

PRODUCT CATALOG

Appliance Parts and HVAC

Address :

2012 Corporate Lane
Suite 124
Naperville, IL 60563

Contact :

P : (331) 702-2051
F : (630) 857-9260
E : info@choicemfg.parts
W : choicemfg.parts



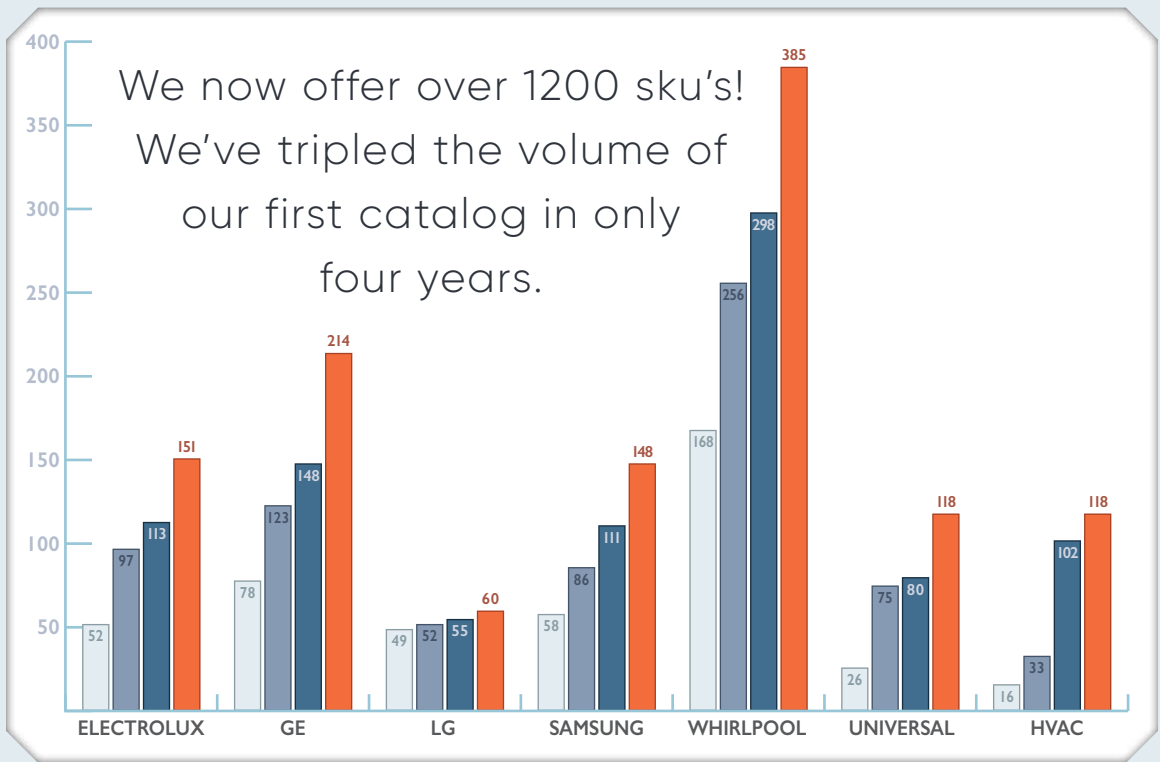

SHIPPING POLICY



We developed our shipping policy with the Distributor in mind. Our goal is to give you a consistent, reliable, and fair freight cost. That way, even if you need a small order quickly, you know exactly what it will cost. Now that's a smart choice.

Choice Manufactured Parts strives to be the leading supplier of Aftermarket Appliance Parts.

Our mission is to continually develop high-quality replacement appliance parts used by technicians every day.





TABLE OF CONTENTS

Belts	4	LG			
Surace Elements	6	Cooking	51		
Bake/Broil Elements	7	Dishwasher	51		
Bosch		Dryer	51		
Cooking	10	Microwave	53		
Dishwasher	10	Refrigerator	53		
Microwave	11	Washer	54		
Washer	12	Samsung		Universal/Misc	
Electrolux		Cooking	58	Accessory	114
Cooking	13	Dishwasher	59	BBQ	114
Dishwasher	17	Dryer	60	Cooking	115
Dryer	18	Microwave	62	Dishwasher	118
Microwave	21	Refrigerator	63	Dryer	118
Refrigerator	22	Washer	70	Ice Machine	123
Washer	26	Whirlpool		Universal/Misc	
GE		Cooking	74	Microwave	119
Cooking	29	Dishwasher	78	Refrigerator	119
Dishwasher	32	Dryer	82	Washer	121
Dryer	35	Microwave	90	Refrigerator Technology	124
HVAC	37	Refrigerator	91	Paint	125
Microwave	38	Small Appliance	103	HVAC/Commercial Ice	
Refrigerator	40	Washer	104	Ice Machine	126
Washer	46	Other OEM		HVAC	133
		Broan	113	Index	140
		Fisher Paykel	113		
		Panasonic	113		
		Subzero	113		
		Tech's Choice	113		



DRYER

	Part Number	Ribs	Length	OEM	Replaces
	134503600CM	4 Ribs	87 ½"	Electrolux	134503600, LB3600
	137292700CM	4 Ribs	89 ½"	Electrolux/GE	137292700
	137315300CM	5 Ribs	90"	Whirlpool	134719300, 137315300, LB5300
	312959CM	5 Ribs	100"	Whirlpool	314774, Y312959
	3394652CM	4 Ribs	79"	Whirlpool	345675, 3456750, 3456755, 4319392, 8066064
	341241CM	4 Ribs	92"	Whirlpool	14210003, 31001026, 31531589, 3389628, 3392665, 3394651, 3399844, 345473, 349533, 53-0186, 53-1080, 53-1528, 53-1589, 53-2671, 660996, 660997, 661561, 693306, 694088, 694416, 694868, 695055, 697388, 8066065, 9906951, 99989673, 99989674 W10127457, W10131364
	395048CM	7 Ribs	87 ⅝"	Fisher Paykel	395048
	40111201CM	4 Ribs	93 ½"	Whirlpool	14218936, 40051501, 40051502, 59174, R0606549, WE12X10005
	4400EL2001ACM	4 Ribs	92"	Whirlpool	4400EL2001B, 4400EL2001C
	6602-001655CM	5 Ribs	92"	Whirlpool	6602-001314, W10205415
	661570CM	4 Ribs	93 ½"	Whirlpool	661570
	8540101CM	6 Ribs	51 ⅓"	Whirlpool	8540348
	8547157CM	4 Ribs	95"	Whirlpool	8547157
	8547168CM	4 Ribs	93 ½"	Whirlpool	WP8547168
	DC66-00805ACM	6 Ribs	100"	Samsung	DC66-00805A
	W10136934CM	5 Ribs	95"	Whirlpool	W10136934

DRYER

	Part Number	Ribs	Length	OEM	Replaces
	W10198086CM	5 Ribs	92 1/2"	Whirlpool	W10198086
	W10205415CM	5 Ribs	95"	Whirlpool	790H4 - 345675, 3456750, 3456755, 4319392, 8066064
	W10388414CM	7 Ribs	51 1/3"	Whirlpool	W10388414
	WE12M51CM	4 Ribs	80"	GE	WE12M51, Fits GE laundry centers
	WE12X82CM	4 Ribs	87 7/8"	GE	WE12X82

WASHER

	Part Number	Ribs/Type	OEM	Replaces
	12112425CM	1 Rib	Whirlpool	Set includes 211124 and 211125.
	134161100CM	4L300	Electrolux	Dry back cover. Also replaces 134511600.
	211124CM	3L410	Whirlpool	Friction cover.
	211125CM	4L424	Whirlpool	Dry back cover.
	21352320CM	SPZ1287	Whirlpool	Dry back cover.
	22003483CM	SPZ1287	Whirlpool	Raw edge.
	27001007CM	4L308	Whirlpool	Dry back cover.
	28808CM	4L330	Whirlpool	Dry back cover.
	38174CM	V-Belt	Whirlpool	Replaces 27001006CM.
	5303280326CM	4L320	Electrolux	Dry back cover.
	W10006384CM	5 Ribs	Whirlpool	21 9/10" long. W10006384
	W11239857CM	5 Ribs	Whirlpool	21 9/10" long. Fits 3.8 - 4.8 CF top load washers.
	WH01X24180CM	5 Ribs	GE	23 1/10" long. Fits top load washers.
	WH01X24697CM	5 Ribs	GE	21" long. Fits top load washers.
	WH01X27538CM	5 Ribs	GE	22 7/8" long. Fits top load washers.
	WH1X2026CM	4L300	GE	Friction cover.

SURFACE ELEMENTS

UNIVERSAL



MP15MA
SURFACE ELEMENT 4D6 1500W
208/240V, 1125/1500W, 6"
diameter, 4 turns, 'D' base.

ELEMENT

MADE IN CHINA



MP15YA
SURFACE ELEMENT 4D6 1500W
208/240V, 1125/1500W, 6"
diameter, 4 turns, 'Y' base.

ELEMENT

MADE IN CHINA



MP21MA
SURFACE ELEMENT 5D8 2100W
208/240V, 1575/2100W, 8"
diameter, 5 turns, 'D' base.

ELEMENT

MADE IN CHINA

UNIVERSAL



MP21YA
SURFACE ELEMENT
5T8 2100W
208/240V, 1575/2100W, 8"
diameter, 5 turns, 'Y' base.

ELEMENT

MADE IN CHINA



MP26MA
SURFACE ELEMEN
5D8 2600W
208/240V, 1950/2600W, 8"
diameter, 5 turns, 'D' base.

ELEMENT

MADE IN CHINA



MP26YA
SURFACE ELEMENT
5T8 2600W
208/240V, 1950/2600W, 8"
diameter, 5 turns, 'Y' base.

ELEMENT

MADE IN CHINA

UNIVERSAL



SP12YA
SURFACE ELEMENT
3T6 1250W
208/240V, 938/1250W, 6"
diameter, 3 turns, 'Y' base.

ELEMENT

MADE IN CHINA



SP21YA
SURFACE ELEMENT 4T8 2100W
208/240V, 1575/2100W, 8"
diameter, 4 turns, 'Y' base.

ELEMENT

MADE IN CHINA



Door Gaskets
OVEN DOOR GASKETS

OG1416	14" - 16"
OG1618	16" - 18"
OG1820	18" - 20"
OG2224	22" - 24"

MADE IN CHINA

BAKE/BROIL ELEMENTS

ELECTROLUX

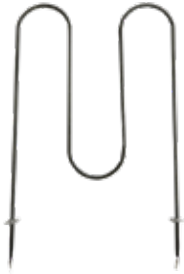

CM3200
BROIL ELEMENT

240V, 2400W. 12"W x 15"L, 3"
Insert, Spade terminal. Replaces
Electrolux 316203200.

ELEMENT

MADE IN CHINA

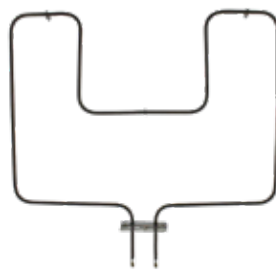

CM5002
BAKE ELEMENT

240V, 3000W. 19 3/4"W x 15 1/2"L, 3
1/4" Insert, Spade terminal.
Replaces Electrolux 318255002.

ELEMENT

MADE IN CHINA



CM5104
BAKE ELEMENT

240V, 2600W. 19 1/4"W x 15 1/4"L, 3
3/8" Insert, Spade terminal.
Replaces Electrolux 316075104.

ELEMENT

MADE IN CHINA

ELECTROLUX

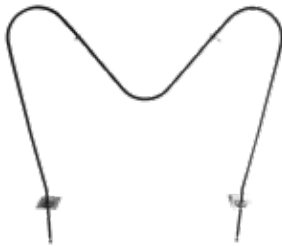

CM775
BAKE ELEMENT

208/240V, 1800/2400W. 19 3/8"W
x 15"L, 3 1/4" Insert, Spade terminal.
Replaces Electrolux 5303051519.

ELEMENT

MADE IN CHINA

GE

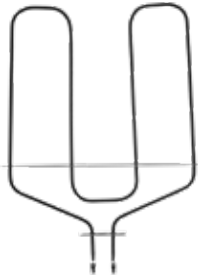

CM44K10002
BROIL ELEMENT

240V, 3410W. 16 1/2"W x 13 1/2"L, 2
3/4" Insert, Spade terminal.
Replaces GE WB44K10002.

ELEMENT

MADE IN CHINA

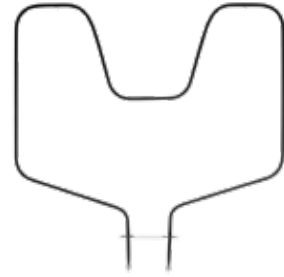

CM44K10005
BAKE ELEMENT

240V, 2585W. 17 3/4"W x 15 1/2"L, 2
1/4" Insert, Spade terminal.
Replaces GE WB44K10005.

ELEMENT

MADE IN CHINA

GE



CM44K5012
BAKE ELEMENT

208/240V, 2138/2850W. 18"W x 15
3/8"L, 4" Insert, Spade terminal.
Replaces GE WB44K5012.

ELEMENT

MADE IN CHINA

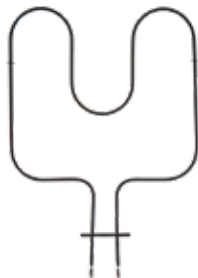

CM44K5013
BAKE ELEMENT

240V, 2000W. 13 3/4"W x 16"L, 2 7/8"
Insert, Spade terminal.
Replaces GE WB44K5013.

ELEMENT

MADE IN CHINA

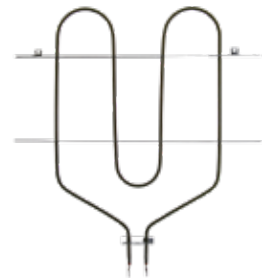

CM44T10009
BROIL ELEMENT

240V, 3410W. 10 1/4"W x 16 1/2"L, 2
1/2" Insert, Spade terminal.
Replaces GE WB44T10009.

ELEMENT

MADE IN CHINA

BAKE/BROIL ELEMENTS

GE



CM44T10010

BAKE ELEMENT

240V, 2585W. 17 3/4"W x 17"L, 2 1/2" Insert, Spade terminal.
Replaces GE WB44T10010.

ELEMENT

MADE IN CHINA

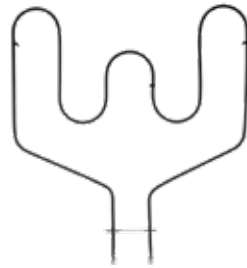

CM44T10011

BAKE ELEMENT

240V, 3410W. 16 1/2"W x 18"L, 2 1/8" Insert, Spade terminal.
Replaces GE WB44T10011.

ELEMENT

MADE IN CHINA

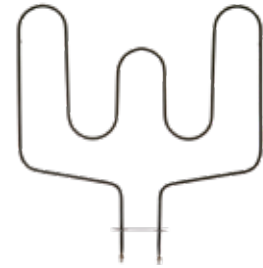

CM44T10014

BAKE ELEMENT

240V, 3800W. 16 7/8"W x 17 3/4"L, 2 1/2" Insert, Spade terminal.
Replaces GE WB44T10014.

ELEMENT

MADE IN CHINA

GE

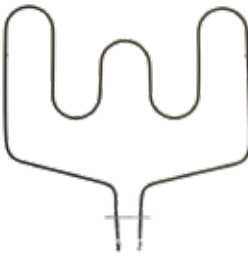

CM44T10018

BAKE ELEMENT

240V, 3400W. 17 3/4"W x 15 1/4"L, 2 1/2" Insert, Spade terminal.
Replaces GE WB44T10018.

ELEMENT

MADE IN CHINA

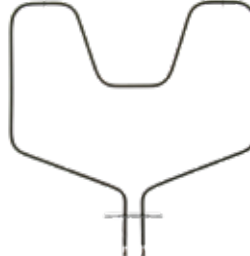

CM44X10009

BAKE ELEMENT

240V, 2585W. 17 3/4"W x 15 1/2"L, 2 7/8" Insert, Spade terminal.
Replaces GE WB44X10009.

ELEMENT

MADE IN CHINA

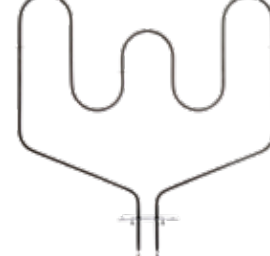

CM44X10016

BAKE ELEMENT

208/240V, 2650/3410W. 17 3/4"W x 15 1/2"L, 3 1/4" Insert, Spade terminal.
Replaces GE WB44X10016.

ELEMENT

MADE IN CHINA

WHIRLPOOL

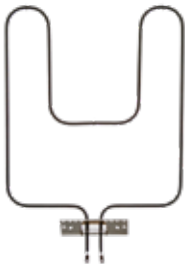

CM44X200

BAKE ELEMENT

208/240V, 2330/3100W. 13 1/4"W x 16 3/4"L, 2 1/2" Insert, Screw terminal.
Replaces GE WB44X200.

ELEMENT

MADE IN CHINA



CM44X5082

BAKE ELEMENT

208/250V, 1869/2700W. 17 5/8"W x 14 3/4"L, 2.55" Insert, Screw terminal.
Replaces GE WB44X5082.

ELEMENT

MADE IN CHINA

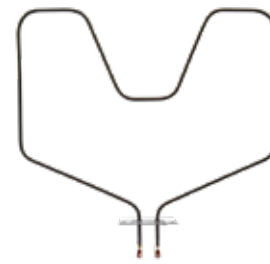

CM44X5099

BAKE ELEMENT

208/250V, 1869/2700W. 18"W x 16"L, 1.625" Insert, Screw terminal.
Replaces GE WB44X5099.

ELEMENT

MADE IN CHINA

BAKE/BROIL ELEMENTS

WHIRLPOOL

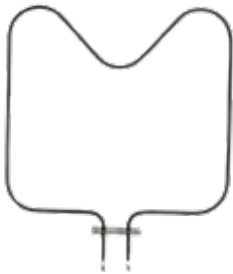

CM4000066

BAKE ELEMENT

208/240V, 2065/2750W, 16"W x 16"L, 2" Insert, Spade terminal.
Replaces Whirlpool Y04000066.

ELEMENT

MADE IN CHINA



CM0750

BAKE ELEMENT

208/240V, 2100/2800W, 18 1/2"W x 16 3/8"L, 3 1/8" Insert, Spade terminal.
Replaces Whirlpool 74010750.

ELEMENT

MADE IN CHINA

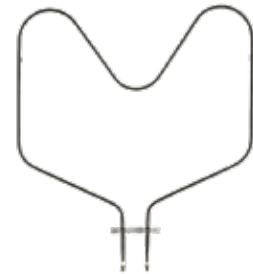

CM308180

BAKE ELEMENT

208/240V, 1950/2600W, 16 1/2"W x 15 7/8"L, 3" Insert, Spade terminal.
Replaces Whirlpool 308180.

ELEMENT

MADE IN CHINA

WHIRLPOOL

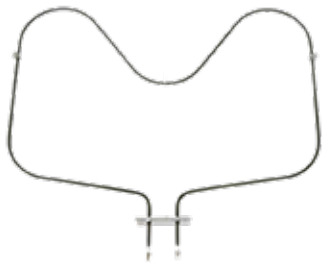

CM8477

BAKE ELEMENT

240V, 2400W. 20 3/8"W x 15 3/4"L, 2 5/8" Insert, Spade terminal.
Replaces Whirlpool W10308477.

ELEMENT

MADE IN CHINA



CM866375

BAKE ELEMENT

208/240V, 1800/2400W. 19 1/2"W x 15 1/2"L, 3 1/2" Insert, Spade terminal.
Replaces Whirlpool 866375.

ELEMENT

MADE IN CHINA

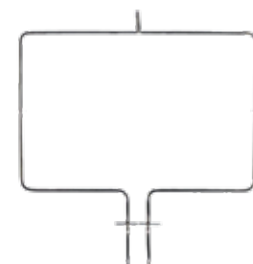

CM9716

BAKE ELEMENT

240V, 3600W. 20.56"W x 16.5"L, 3.11" Insert, Spade terminal.
Replaces Whirlpool W10779716.

ELEMENT

MADE IN CHINA

CHECK OUT OUR LINEUP OF COOKING PARTS



COOKING



422133CM
INFINITE SWITCH

120V, 15 Amp ceramic element
Fits Bosch glasstop free standing
ranges.

SWITCH

MADE IN CROATIA



422748CM
POTENTIOMETER

Controls gas flow to surface
burners. Fits Thermador gas
ranges and cooktops.

ELECTRICAL

MADE IN CHINA



422749CM
POTENTIOMETER

Adjusts burner temperature
through current flow to control
gas flow to surface burners. Fits
Bosch and Thermador ranges.

ELECTRICAL

MADE IN CHINA

COOKING



755058CM
RANGE IGNITER

3.4 - 3.6 Amp, 1.5" block, 3 3/4"
cage, 11" leads with two pin
connector. Fits Bosch gas ranges.

IGNITER

MADE IN MEXICO

DISHWASHER



10004364CM
ROLLER

1.4" diameter lower rack roller
with axle. Fits Bosch dishwashers.

TRIM

MADE IN CHINA



12004119CM
DOOR SPRING KIT

Door spring kit includes 00754866
spring kit and 00632896 holders.
Fits Bosch under-counter
dishwashers.

MECHANICAL

MADE IN CHINA

DISHWASHER



165314CM
RACK ROLLER

Lower rack roller. Fits Bosch,
Thermador and Gaggenau
dishwashers.

TRIM

MADE IN CHINA



425458CM
WATER VALVE

120V, 60 Hz with compression
inlet. Fits Bosch, Thermador, and
Gaggenau dishwashers.

WATER VALVE

MADE IN CHINA



607335CM
WATER VALVE

120V, 60 Hz with mounting
bracket. Fits Bosch, Thermador
and Gaggenau dishwashers.

WATER VALVE

MADE IN CHINA

DISHWASHER



611475CM
ROLLER

1.37" diameter lower rack roller with axle. Fits Bosch dishwashers.

TRIM

MADE IN CHINA



611666CM
ROLLER

1.23" diameter upper rack roller with axle. Fits Bosch dishwashers.

TRIM

MADE IN CHINA



622058CM
WATER VALVE

120V, 60 Hz. Fits Bosch, Thermador and Gaggenau dishwashers.

WATER VALVE

MADE IN CHINA

DISHWASHER



628334CM

WATER VALVE
120V, 60 Hz with GHT inlet.
Fits Bosch dishwashers.

WATER VALVE

MADE IN CHINA



633970CM

WATER VALVE
120V, 60 Hz with compression inlet. Fits Bosch dishwashers.

WATER VALVE

MADE IN CHINA



637572CM

WATER VALVE
120V, 60 Hz with GHT inlet. Fits Bosch dishwashers.

WATER VALVE

MADE IN CHINA

DISHWASHER



642239CM
WATER PUMP

120V, 60 Hz, 0.6A
Fits Kenmore Elite 630; Bosch SHE, SHU, SHV, SHX, S35K and SGV; and Thermador DWHD.

PUMP

MADE IN CHINA

MICROWAVE



491133CM

WAVE GUIDE COVER
5 1/2" x 4 3/8" with cutouts.
Fits Bosch microwaves.

TRIM

MADE IN CHINA



612102CM

WAVE GUIDE COVER
4 3/8" x 4 3/8".
Fits Bosch microwaves.

TRIM

MADE IN CHINA

WASHER



422244CM

WATER VALVE

120V, 60 Hz, dual cold water valve assembly. Fits Bosch front load washers.

WATER VALVE

MADE IN ITALY



422245CM

WATER VALVE

110-127V, 60 Hz hot water valve. Fits Bosch front load washers.

WATER VALVE

MADE IN CHINA



436440CM

WATER PUMP

120V, 60 Hz, 0.85A. Fits Bosch front load washers.

PUMP

MADE IN CHINA

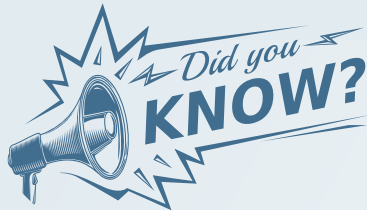

LOOK FOR THE BALL BEARING ADVANTAGE!

Parts marked with this special badge indicate that they have been upgraded to use Ball Bearings.

The Ball Bearing Advantage

- ➔ Bearings save power, lubrication, and labor. With the rolling motion, bearings reduce the friction over a surface. This allows for sliding to occur instead of a pushing or a pulling motion. This process exerts less energy, and saves power.
- ➔ Our bearings don't require maintenance. Bearing maintenance can compromise the bearing causing leaks, or introducing grime into smooth operation.

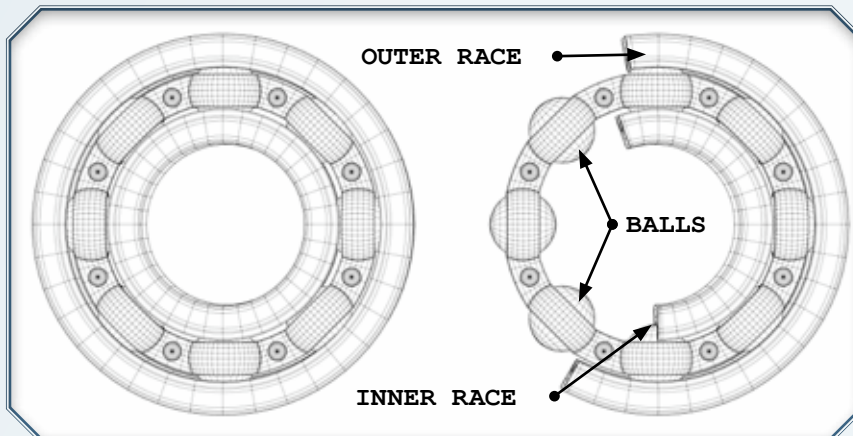

BALL BEARINGS USUALLY COST SLIGHTLY MORE THAN THEIR SLEEVE BEARING ALTERNATIVE.

This cost difference is more than made up, however, in the quality, reliability, and endurance of a Ball Bearing vs a sleeve bearing -

SAVING TECHS FROM MAKING RETURN CALLS

COOKING

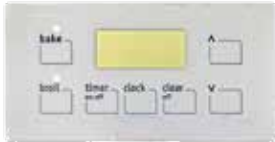

316220722CM
OVERLAY

7 button overlay. Used with 316455400, 316455410, 31645530, 5304518660 and 5304518661 boards.

TRIM

MADE IN UNITED STATES



316220725CM
OVERLAY

7 button overlay. Used with 316455400, 316455410, 31645530, 5304518660 and 5304518661 boards.

TRIM

MADE IN UNITED STATES



316220728CM
OVERLAY

7 button overlay. Used with 316455400, 316455410, 534518660 and 5304518661 boards.

TRIM

MADE IN UNITED STATES

COOKING



316220729CM
OVERLAY

7 button overlay. Used with 316455400, 316455410, 534518660 and 5304518661 boards.

TRIM

MADE IN UNITED STATES



316220804CM
OVERLAY

10 button overlay. Used with Es300 318185403, 318185414, 318185447 boards.

TRIM

MADE IN UNITED STATES



316220805CM
OVERLAY

10 button overlay. Used with ES300 318185403, 318185414, 318185447 boards.

TRIM

MADE IN UNITED STATES

COOKING



316238201CM
INFINITE SWITCH

240V, 15A for dual radiant element. Fits Electrolux glass top ranges.

SWITCH

MADE IN CROATIA



316354400CM
OVERLAY

7 button overlay. Used with 316455420 and 31645530 boards.

TRIM

MADE IN UNITED STATES



316354402CM
OVERLAY

7 button overlay. Used with 316455420 and 31645530 boards.

TRIM

MADE IN UNITED STATES

ELECTROLUX

COOKING



316419137CM

OVERLAY

10 button overlay. Used with 316557118 and 5304509493 boards.

TRIM

MADE IN UNITED STATES



316419140CM

OVERLAY

8 button black, works with ES200 controllers. Fits Electrolux gas and electric ranges.

TRIM

MADE IN UNITED STATES



316419141CM

OVERLAY

10 button overlay. Used with 316557118 and 5304509493 boards.

TRIM

MADE IN UNITED STATES

COOKING



316419145CM

OVERLAY

10 button black overlay. Used with 5304508925 board.

TRIM

MADE IN UNITED STATES



316419353CM

OVERLAY

12 button black overlay. Used with 5304509231 and 5304510064 boards.

TRIM

MADE IN UNITED STATES



316419380CM

OVERLAY

12 button overlay. Used with 5304514107 and 5304514108 boards.

TRIM

MADE IN UNITED STATES

COOKING



316419821CM

OVERLAY

28 button black overlay. Use with ES540 316560105 and 316560106 controllers.

TRIM

MADE IN UNITED STATES



316419828CM

OVERLAY

28 button overlay for ES540 series controllers. Fits Electrolux ranges.

TRIM

MADE IN UNITED STATES



316436000CM

INFINITE SWITCH

5.2-6.25A, 1250-1500W, 240V. Fits Electrolux 6" Elements.

SWITCH

MADE IN MEXICO

COOKING



316436001CM
INFINITE SWITCH
8.8-10.8A, 240V
Fits Electrolux 8" Elements.

SWITCH

MADE IN MEXICO



316455400CM
OVEN CONTROL
7 Button Control Board. Fits
Electrolux Electric ranges.

DON'T FORGET THE OVERLAY; PAGE 11

ELECTRICAL

MADE IN CHINA



316455410CM
OVEN CONTROL
7 Button Control Board. Fits
Electrolux Gas ranges.

DON'T FORGET THE OVERLAY; PAGE 11

ELECTRICAL

MADE IN CHINA

COOKING



316455420CM
OVEN CONTROL
7 Button Control Board. Fits
Electrolux Electric ranges.

DON'T FORGET THE OVERLAY; PAGE 11

ELECTRICAL

MADE IN CHINA



316489400CM
RANGE IGNITER
3.4-3.6 AMP, 1 1/2" block, 1 3/4" cage,
15 3/4" leads w/ male pins. Bake
Igniter for Electrolux ranges.

IGNITER

MADE IN MEXICO



316489403CM
RANGE IGNITER
3.2 - 3.6 amp, 1 1/4" block, open
cage, with 16" lead. Fits Electrolux
gas ranges.

IGNITER

MADE IN MEXICO

COOKING



316655001CM
OVERLAY
Black thirty button overlay. Use
with 316650010 and 316650003
controllers.

TRIM

MADE IN UNITED STATES



318191023CM
INFINITE SWITCH
240V, 15A for dual surface
element. Fits Electrolux slide in
glass top ranges.

SWITCH

MADE IN CROATIA



3203459CM
SAFETY VALVE
3.5 - 3.5 amp, 120V, 3/8" outlet.
Fits Early Tappan and Frigidaire
ranges.

SAFETY VALVE

MADE IN MEXICO

ELECTROLUX

COOKING

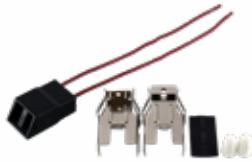
**5303935058CM****RANGE BLOCK (BAKELITE)**

Includes interchangeable mounting brackets, block, wire nuts and heat shrink. Universal-fits multiple brands.

RECEPTACLE

MADE IN CHINA

**5303935066CM****RANGE IGNITER**

3.4-3.6" Amp, 1 1/2" block, 3 3/4" cage, 17 1/2" bare leads with wire nuts. Universal application, fits Electrolux and more.

IGNITER

MADE IN MEXICO

**5303935067CM****5.5" IGNITER**

3.2-3.6 Amp, 5 1/2" overall length. Fits Electrolux and more.

IGNITER

MADE IN MEXICO

COOKING

**5304506545CM****RANGE IGNITER**

3.2 - 3.6 amp, 1 1/4" block, open cage, with 7" lead. Fits Electrolux gas ranges.

IGNITER

MADE IN MEXICO

**5304509706CM****RANGE IGNITER**

3.4-3.6 Amp, 1 1/2" block, 3 3/4" cage, 16 1/2" leads w/ pin connector and two male spade breaks.

IGNITER

MADE IN MEXICO

**154459903CM****TOUCHPAD**

Touchpad with 12 keys and 16 embedded LED lights. Used in Electrolux Professional series.

ELECTRICAL

MADE IN UNITED STATES

COOKING

**154513601CM****WATER VALVE**

120V, 60Hz, with compression inlet. Fits Electrolux dishwashers.

WATER VALVE

MADE IN CHINA

**154578801CM****CABLE**

13" overall length. Fits Electrolux dishwashers.

MECHANICAL

MADE IN CHINA

DISHWASHER

**154430501CM****SPRING**

Door counter balance spring. Fits Electrolux dishwashers.

MECHANICAL

MADE IN CHINA

DISHWASHER

**154579101CM**

SPRING

Door hinge cable spring - 4.25" overall length. Fits Electrolux dishwashers.

MECHANICAL

MADE IN UNITED STATES

**154580301CM**

PUMP

120V, 60Hz, drain pump and housing assembly. Fits Electrolux dishwashers.

PUMP

MADE IN CHINA

**154622001CM**

DRAIN VALVE

Fits between drain pump and intermediate drain hose. Fits Electrolux fully integrated DW.

PUMP

MADE IN CHINA

DISHWASHER

**154637401CM**

WATER VALVE

Direct replacement with mounting bracket. Fits Electrolux built dishwashers.

WATER VALVE

MADE IN CHINA

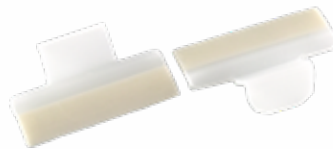
**154701001CM**

SPLASH SHIELD (KIT)

Includes two corner pieces. Fits Electrolux built dishwashers.

MECHANICAL

MADE IN CHINA

**154827601CM**

DOOR GASKET

70" long, black foam rubber. Fits Electrolux built dishwashers.

GASKET

MADE IN CHINA

DISHWASHER

**5300809640CM**

ROLLER ASSY

Gray Roller and Shaft assembly for lower rack. Fits Electrolux dishwashers.

TRIM

MADE IN CHINA

**5304500204CM**

SEAL

Flange seal for bottom of door. Fits Electrolux Dishwashers.

GASKET

MADE IN CHINA

**5304516818CM**

DOOR LATCH

125/250V, 50/60Hz, 1/2 HP. Fits Electrolux Dishwashers.

SWITCH

MADE IN CHINA

ELECTROLUX

DISHWASHER

**5304518968CM****SUPPORT (LOWER ARM)**Supports lower spray arm.
Fits Electrolux Dishwashers.

MECHANICAL

MADE IN CHINA

**807047901CM****WATER VALVE**120V, 60Hz, with GHT inlet.
Fits over 400 Electrolux
dishwashers models.

WATER VALVE

MADE IN CHINA

**807048001CM****FLAPPER**Check valve flapper, prevents
backflow from drain hose.
Fits Electrolux Dishwashers.

MECHANICAL

MADE IN CHINA

DISHWASHER

**809006501CM****LOWER SEAL**22 1/2" long with rubber strips.
Fits Electrolux built dishwashers.

GASKET

MADE IN CHINA

**A00126401CM****WATER PUMP**120V, 35W, 0.8A, 3600 RPM.
1/4" male terminals.

PUMP

MADE IN CHINA

**A00126501CM****PUMP - DW**120V, 60 Hz, 0.8A, 35W, 3600 RPM.
Fits Electrolux dishwashers.

PUMP

MADE IN CHINA

DRYER

**131476300CM****BLOWER WHEEL**8" Diameter, 1/2" shaft with flat.
Fits Electrolux dryers.

MECHANICAL

MADE IN CHINA

**131775600CM****BLOWER ASSEMBLY & HOUSING,
WITH COVER**Complete housing and captive
blower assembly.
Fits Electrolux dryers.

MECHANICAL

MADE IN CHINA

**131825900CM****BEARING**

Bearing only from 5303281153 kit.

MECHANICAL

MADE IN CHINA

DRYER

**131863007CM**

IDLER ARM

Newer style, includes roller, shaft and bracket. Fits Electrolux dryers.

MECHANICAL

MADE IN CHINA

**131873500CM**

KNOB

White timer knob. Fits Electrolux dryers with control panel on front.

TRIM

MADE IN CHINA

**134120900CM**

THERMAL FUSE

220F single blow limiter. Fits Electrolux dryers.

THERMOSTAT

MADE IN CHINA

DRYER

**134440200CM**

FELT SEAL, UPPER

Fits late model Electrolux dryers.

MECHANICAL

MADE IN CHINA

**134792700CM**

ELEMENT - DRYER

5500W, 3+1 terminal element with housing. Fits Electrolux dryers.

ELECTRICAL

MADE IN MEXICO

**134793500CM**

IDLER PULLEY

Primarily used in the Canadian market. Fits Electrolux dryers with controls in front.

MECHANICAL

MADE IN CHINA

DRYER

**134793511CM**

IDLER PULLEY

Idler arm and pulley assembly. Fits newer Electrolux dryers with rollers.

MECHANICAL

MADE IN CHINA

**134813600CM**

SWITCH, DOOR

2 wire door switch for models without light. Fits Electrolux dryers.

SWITCH

MADE IN CHINA

**134844410CM**

KNOB

1 1/2" diameter, with 1/4" "D", white with gray accents. Fits Electrolux washers and dryers.

TRIM

MADE IN CHINA

ELECTROLUX

DRYER



137114000CM

ELEMENT - DRYER

4700W, 2 terminal element with housing. Fits Electrolux dryers.

ELECTRICAL

MADE IN MEXICO



137513300CM

DRUM GLIDE

Half glide ring snaps into drum, two required. Fits late model Electrolux dryers.

MECHANICAL

MADE IN CHINA



137539200CM

THERMAL LIMITER

L314 degree cutout with mounting bracket. Fits Electrolux dryers.

THERMAL LIMITER

MADE IN CHINA

DRYER



33001755CM

BAFFLE

Short 3 1/2" baffle. Fits Whirlpool dryers.

TRIM

MADE IN CHINA



33002032CM

BAFFLE

Tall 5 1/2" baffle. Fits Whirlpool dryers.

TRIM

MADE IN CHINA



5303281153CM

BEARING KIT

Includes, shaft, bearing, grounding ball, plate, screws and lube. Pre-tapped plate for easy install.

MECHANICAL

MADE IN CHINA

DRYER



5303283286CM

FELT

7/8" W x 42+ " L lower basket seal. Fits Electrolux dryers.

GASKET

MADE IN CHINA



5303937182CM

FELT

16 1/2" x 1", upper seal, includes high temp adhesive. Fits Electrolux dryers.

GASKET

MADE IN CHINA



5303937183CM

FELT

48" x 1", lower seal, includes high temp adhesive. Fits Electrolux dryers.

GASKET

MADE IN CHINA

DRYER

**5304457724CM**

REBUILD KIT

Kit includes bearing kit, belt, idler and top and bottom felt seals. Fits Electrolux dryers from 2002 to present.

MECHANICAL

MADE IN CHINA

**5304523152CM**

ROLLER

Roller only with ball bearing. Fits newer Electrolux dryers with rollers.

MECHANICAL

MADE IN CHINA

**5304523155CM**

ROLLER AND SHAFT

Includes 5304523151 shaft, 5304523152 roller, and 5304523154 spacer. Fits newer Electrolux dryers with rollers.

MECHANICAL

MADE IN CHINA

DRYER

**5304529782CM**

MOTOR

115V, 60Hz, 5.0 Amp, 1725 RPM w/ 5 groove pulley. Also replaces 134693302 w/ 4 groove pulley. Fits newer Electrolux dryers.

MOTOR

MADE IN CHINA

MICROWAVE

**5304477389CM**

DOOR LATCH

Latch and lever for oven door. Fits Electrolux over counter microwaves.

TRIM

MADE IN CHINA

**5304477398CM**

HANDLE

11 3/4" long, gloss black. Fits Electrolux over the range microwaves.

TRIM

MADE IN CHINA

MICROWAVE

**5304509444CM**

GREASE FILTER

5" x 7 7/8" x 3/32" aluminum filter. Fits Electrolux over-counter microwaves.

FILTER

MADE IN MEXICO

**5304509457CM**

LATCH HOOK

Holds three micro switches (not included). Fits Electrolux over counter microwaves.

TRIM

MADE IN CHINA

**5304517871CM**

GREASE FILTER

Grease Filter 5" x 7 7/8" x 3/32" aluminum filter. Fits Electrolux over-counter microwaves.

FILTER

MADE IN MEXICO

ELECTROLUX

REFRIGERATOR



218470300CM

WATER VALVE

120V/60Hz single coil valve with 3/4" GHT inlet. Fits Electrolux top mount refrigerators and steam dryers. Replaces Horton HC70300.

WATER VALVE

MADE IN UNITED STATES



218698900CM

WATER VALVE

115V, dual coil valve with 3/4" GHT inlet, threaded outlet. Fits Electrolux SxS refrigerators. Replaces Horton HC98900.

WATER VALVE

MADE IN UNITED STATES



218969902CM

DF THERMOSTAT

L42-21F, one male, one female bullet connector. Metal tube mount. Fits Electrolux freezers.

THERMOSTAT

MADE IN CHINA

REFRIGERATOR



240338101CM

DOOR BIN

23.26" white door bin. Fits Electrolux top mount refrigerators.

TRIM

MADE IN CHINA



240356402CM

DOOR BIN

Clear gallon door bin for FF door. Fits Electrolux SxS refrigerators.

TRIM

MADE IN CHINA



240570206CM

OVERLAY

Black four button overlay. Fits Electrolux SxS refrigerators.

TRIM

MADE IN UNITED STATES

REFRIGERATOR



240597203CM

SENSOR,TEMPERATURE,10K,NTC

5/16" Dia, 10K Ohm. Fits Electrolux french door refrigerators.

SENSOR

MADE IN CHINA



241509402CM

EVAPORATOR FAN MOTOR

12V DC, 120mA
Fits Electrolux built refrigerators.

MOTOR

MADE IN CHINA



241537103CM

COLD CONTROL

125/250V, 8/5 FLA, 32" sensing bulb. Fits Electrolux top mount refrigerators.

ELECTRICAL

MADE IN CHINA

REFRIGERATOR

**241542001CM**

AIR DUCT

Upper portion air deflector and diffuser. Fits Electrolux top mount refrigerators.

DAMPER

MADE IN UNITED STATES

**241675704CM**

SOLENOID

115V, 60Hz, actuating solenoid and yoke assembly for ice door. Fits Electrolux SxS refrigerators.

MECHANICAL

MADE IN CHINA

**241696606CM**

CONDENSER FAN MOTOR

115V, 0.15A 50/60Hz.
Fits Electrolux models.

MOTOR

MADE IN CHINA

REFRIGERATOR

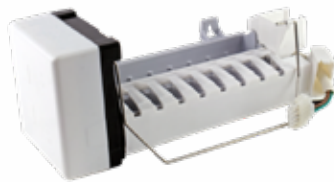
**241798231CM**

ICE MAKER

8 cube heated mold ice maker with 5 female pin connector. Fits Electrolux SxS refrigerators.

ICE MAKERS

MADE IN CHINA

**241920106CM**

FILL TUBE

Fill tube and insulated spout assembly.

WATER VALVE

MADE IN CHINA

**241993001CM**

SUPPORT

White crispier drawer rear support stud. Fits Electrolux SxS refrigerators.

TRIM

MADE IN CHINA

REFRIGERATOR

**241993101CM**

SUPPORT

White crispier drawer front support stud. Fits Electrolux SxS refrigerators.

TRIM

MADE IN CHINA

**242018304CM**

CONDENSER MOTOR

115V, 60Hz, 3.1W condenser fan motor. Fits multiple types of Electrolux refrigerators.

MOTOR

MADE IN CHINA

**242044020CM**

DEFROST HEATER

18"W, 375 Watt with bullet plugs. Fits Electrolux top mount refrigerators.

DEFROST

MADE IN CHINA

ELECTROLUX

REFRIGERATOR



242046001CM

DEFROST THERMOSTAT

L47-22F with tube mount. Can also be used for 240386402 by removing plugs.

THERMOSTAT

MADE IN CHINA



242077705CM

EVAPORATOR FAN MOTOR

115V, 60Hz, 2 1/2W evaporator fan motor. Fits Electrolux top mount and SxS refrigerators.

MOTOR

MADE IN CHINA



242196204CM

LED LIGHT

LED 3 cluster light board. Fits Electrolux french door refrigerators and upright freezers.

ELECTRICAL

MADE IN CHINA

REFRIGERATOR



242252603CM

WATER VALVE

120V, 1/4" compression inlet- 1/4" push connect outlet. Fits Electrolux top mount refrigerators.

WATER VALVE

MADE IN CHINA



242252702CM

WATER VALVE

4 outlet, supplies ice maker and water dispenser. Fits Electrolux SxS refrigerators.

WATER VALVE

MADE IN CHINA



242253002CM

WATER VALVE

5 outlet, supplies ice maker and water dispenser. Fits Electrolux french door refrigerators.

WATER VALVE

MADE IN CHINA

REFRIGERATOR



242303001CM

DAMPER ASSEMBLY

Damper and motor control assembly. Fits Electrolux SxS refrigerators.

DAMPER

MADE IN CHINA

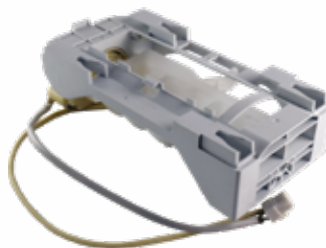

243297609CM

ICE MAKER

10 cube flex tray model. Fits Electrolux french door models.

ICE MAKERS

MADE IN CHINA



297250000CM

EVAPORATOR FAN MOTOR

115V, 60Hz, 0.18 Amps, 8W Evap Fan motor. Fits Electrolux upright freezers.

MOTOR

MADE IN CHINA

REFRIGERATOR

**5303917625CM**

DEFROST THERMOSTAT
L47-22F tube mount with bullet connectors. Fits Electrolux refrigerator.

THERMOSTAT

MADE IN CHINA

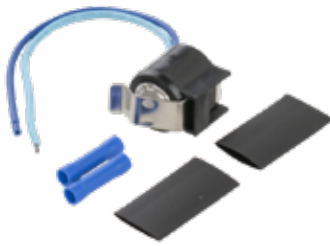
**5303918202CM**

DEFROST THERMOSTAT
L47-22F tube mount with 6" stripped leads. Fits Electrolux top mount refrigerators.

THERMOSTAT

MADE IN CHINA

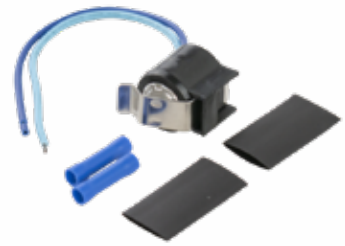
**5303918214CM**

DEFROST THERMOSTAT
L47-22F tube mount with 6.5" stripped leads. Includes butt connectors and heat-shrink. Fits Electrolux SxS refrigerators.

THERMOSTAT

MADE IN CHINA

REFRIGERATOR

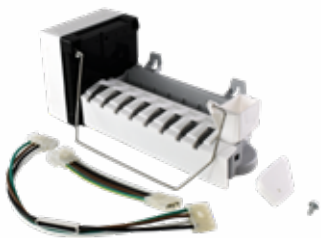
**5303918277CM****ICE MAKER**

Use a combination of supplied harnesses to replace several other models. Fits Frigidaire built refrigerators.

ICE MAKERS

MADE IN CHINA

**5303918344CM****ICE MAKER**

8 cube ice mold with short 5 pin harness, fill tray on side. Fits Electrolux SxS refrigerators.

ICE MAKERS

MADE IN CHINA

**5303918493CM****ICE MAKER**

8 cube heated mold with female pin connectors. Fits Electrolux french door refrigerators.

ICE MAKERS

MADE IN CHINA

REFRIGERATOR

**5303918549CM****EVAPORATOR FAN MOTOR**

120V, 0.9A, 6W, 60Hz, 3000RPM
Fits Electrolux refrigerators.

MOTOR

MADE IN CHINA

**5304404821CM****COLD CONTROL**

120V, 50/60Hz, with 16" cap tube. Fits Electrolux top mount refrigerators.

THERMOSTAT

MADE IN CHINA

**5304458371CM****ICE MAKER**

8 cube ice mold with 5 pin harness. Fits Electrolux SxS refrigerators.

ICE MAKERS

MADE IN CHINA

ELECTROLUX

REFRIGERATOR

**5304513033CM****COLD CONTROL**

125/250V, 8/5 FLA, 19 3/4" sensing bulb. Fits Electrolux freezers.

ELECTRICAL

MADE IN CHINA

**5304521062CM****LED LIGHT BOARD**

3 cluster, 6500K LED light board. Fits Electrolux french door refrigerators.

ELECTRICAL

MADE IN CHINA

**5305877995CM****PERMAGUM**

4oz food safe pliable sealer. Use to seal ice maker inlet water harness or water tubes.

GASKET

MADE IN CHINA

REFRIGERATOR

**297250000CM****EVAPORATOR FAN MOTOR**

115V, 60Hz, 0.18 Amps, 8W Evap Fan motor. Fits Electrolux upright freezers.

MOTOR

MADE IN CHINA

**5303917625CM****DEFROST THERMOSTAT**

L47-22F tube mount with bullet connectors. Fits Electrolux refrigerator.

THERMOSTAT

MADE IN CHINA

WASHER

**131763202CM****LID SWITCH**

Latch/Switch assembly. Fits Electrolux front load washers.

SWITCH

MADE IN CHINA

WASHER

**131763310CM****STRIKER**

Mounts on door, strikes door switch. Fits front load washers.

MECHANICAL

MADE IN CHINA

**134371220CM****VALVE, SHORT TUBES W/NTC**

3 coil valve with 5K ohm thermistor. Fits Electrolux front load washers.

WATER VALVE

MADE IN CHINA

**134144700CM****SPRING**

Includes insulators. Front load suspension springs.

MECHANICAL

MADE IN CHINA

WASHER

**134515300CM****DOOR BOOT**

Door boot and spacers. Fits late model Electrolux front load washers.

MECHANICAL

MADE IN CHINA

**134550800CM****HINGE**

8 1/4" base with swivel bushings. Fits Electrolux front load washers.

TRIM

MADE IN CHINA

**134637810CM****WATER VALVE**

4 coil inlet valve. Fits Electrolux front load machines.

WATER VALVE

MADE IN CHINA

WASHER

**134762000CM****PRESSURE SWITCH**

Pressure switch with snap tab mounting. Fits Electrolux front load washers.

SWITCH

MADE IN CHINA

**134762010CM****PRESSURE SWITCH**

Pressure switch with snap tab mounting. Fits Electrolux front load washers.

SWITCH

MADE IN CHINA

**134936800CM****LID LOCK SWITCH**

Lid lock and switch assembly. Fits Electrolux top load washers.

SWITCH

MADE IN CHINA

WASHER

**134959340CM****WATER VALVE**

120V, dual solenoid with thermistor and extended 3/4" GHT inlet.

WATER VALVE

MADE IN MEXICO

**137108000CM****WATER PUMP**

120V, 60Hz, 1.2A, 50W. Fits Electrolux front load washers.

PUMP

MADE IN CHINA

**137221600CM****WATER PUMP ASSEMBLY**

120V, 60 Hz, 80W, 1.4A. Fits Electrolux front load washers.

PUMP

MADE IN CHINA

ELECTROLUX

WASHER

**137240800CM**

WATER PUMP

120V, 60 Hz, 1.25A, 85W.
Fits Electrolux front load washers.

PUMP

MADE IN CHINA

**137311900CM**

WATER PUMP

120V, 60 Hz, 1.4A, 80W.
Fits Electrolux front load washers.

PUMP

MADE IN CHINA

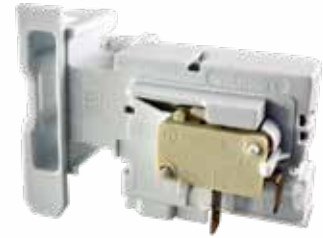
**137353300CM**

LID LOCK SWITCH

Lid lock and switch assembly.
Fits Electrolux laundry centers.

SWITCH

MADE IN CHINA

WASHER

**137353302CM**

LID LOCK SWITCH

Lid lock and switch assembly.
Fits Electrolux laundry centers.

SWITCH

MADE IN CHINA

**137353303CM**

LID LOCK SWITCH

Latch and lock assembly for
washer section.
Fits Electrolux laundry centers.

SWITCH

MADE IN CHINA

**5303161174CM**

SPRING

Internal transmission spring.
Fits Electrolux top load washers.

MECHANICAL

MADE IN CHINA

WASHER

**5304485917CM**

SHOCK KIT

Includes two shocks and
hardware.
Fits front load washers.

MECHANICAL

MADE IN CHINA

**5304505231CM**

DOOR LOCK

Latch and lock assembly.
Fits Electrolux front load washers.

SWITCH

MADE IN CHINA

**5308002385CM**

SNUBBER

7 1/2" diameter dampening pad,
mounts below milk stool.
Fits Electrolux top load washers.

MECHANICAL

MADE IN CHINA

COOKING



WB02K10254CM

ANTI TIP BRACKET

Can be screwed to floor or back wall to prevent stove from tipping. Fits GE and other brand ranges.

TRIM

MADE IN CHINA



WB02X24790CM

BUMPER

1" silicone bumper for gas grates. Fits GE gas ranges.

TRIM

MADE IN CHINA



WB03T10284CM

KNOB

Chrome surface burner knob. Fits GE ranges with sealed burners.

TRIM

MADE IN CHINA

COOKING



WB07K10043CM

HANDLE END CAP (WHITE)

White oven door handle end-cap, fits both right and left side-long. Fits GE ranges.

TRIM

MADE IN CHINA



WB07X10034CM

HANDLE END CAP (BLACK)

Black oven door handle end-cap, fits both right and left side-long. Fits GE ranges.

TRIM

MADE IN CHINA



WB13K21CM

RANGE IGNITER

3.4-3.6 Amp, 1.5" block w/double wing mount, 7 7/8" leads with female pins. Replaces both back or broil igniter for GE ranges.

IGNITER

MADE IN MEXICO

COOKING

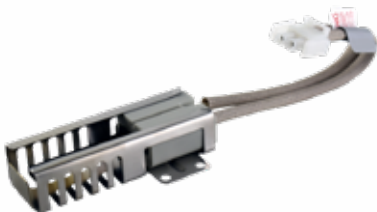

WB13T10045CM

RANGE IGNITER

3.4-3.6 Amp, 1 1/2" block, 3 3/4" cage, 8" leads w/female pins. Replaces both back or broil igniter for GE slide in ranges.

IGNITER

MADE IN MEXICO



WB13X25262CM

RANGE IGNITER

3.2 - 3.6 amp, 1 1/4" block, open cage, with lead. Fits broil burner on GE gas ranges.

IGNITER

MADE IN MEXICO



WB13X25500CM

RANGE IGNITER

3.2 - 3.6 amp, 1 1/4" block, open cage, with 10" lead. Fits bake burner on GE gas ranges.

IGNITER

MADE IN MEXICO

COOKING



WB16X28654CM

BURNER CAP

Small 2.3" Diameter. Fits GE Gas ranges.

TRIM

MADE IN CHINA



WB17T10006CM

RANGE BLOCK - BAKELITE

Includes two brackets and 67" leads. Canada code compliant.

RECEPTACLE

MADE IN CHINA

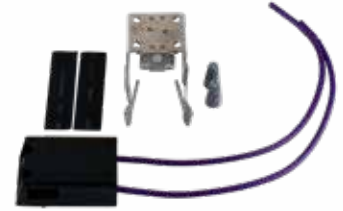

WB17x5113CM

RANGE BLOCK (BAKELITE)

Includes "L" mounting bracket, wire nuts and heat shrink tape. Used with WB30M1 and M2 Elements.

RECEPTACLE

MADE IN CHINA

COOKING



WB23M24CM

INFINITE SWITCH

240V, 5.4 - 7.0A for 6" element. Fits GE ranges.

SWITCH

MADE IN MEXICO



WB23M91CM

INFINITE SWITCH

5.2 - 6.6 Amp, 1400W, 240V for 6" ceramic element. Fits GE ranges.

SWITCH

MADE IN MEXICO



WB24T10022CM

INFINITE SWITCH

240V, 1250W, 4.4 - 5.8A switch. Fits GE ranges.

SWITCH

MADE IN MEXICO



WB24T10025CM

INFINITE SWITCH

240V, 2500W, 8.9-11.0A for 8" element. Fits GE ranges.

SWITCH

MADE IN MEXICO

COOKING



WB24T10027CM

INFINITE SWITCH

240V, 2040W, 7.5-9.3A for 8" element. Fits GE ranges.

SWITCH

MADE IN MEXICO



WB24T10029CM

INFINITE SWITCH

240V, 1560W, 4.4-7.4A for 6" element. Fits GE ranges.

SWITCH

MADE IN MEXICO



WB24T10058CM

INFINITE SWITCH

240V, 15A, 2600W for radiant element. Fits glass top ranges.

SWITCH

MADE IN CROATIA



WB24T10063CM

INFINITE SWITCH

240V, 15A, dual switch with jumper wire. Fits GE ranges.

SWITCH

MADE IN CROATIA

COOKING



WB24T10119CM
INFINITE SWITCH
120V, 15 Amp for
haliant burner. Fits GE
ceramatop ranges.

SWITCH MADE IN CROATIA



WB24T10145CM
INFINITE SWITCH
240V, 5.4-7.0 Amp switch
for 6" element. Fits GE
ranges.

SWITCH MADE IN MEXICO



WB24T10146CM
INFINITE SWITCH
240V, 7.2-9.0 Amp switch
for 8" element. Fits GE
ranges.

SWITCH MADE IN MEXICO



WB24T10153CM
INFINITE SWITCH
120V, 15 Amp dual
9" burner. Fits GE
ceramatop ranges.

SWITCH MADE IN CROATIA

COOKING



WB23T10015CM
OVEN SENSOR
6" probe, 1000 Ohm, with 4"
wires and disconnect block. Fits
thousands of GE electric range
models.

SENSOR MADE IN CHINA



WB27T11005CM
OVERLAY
10 button black overlay.
Used with WB27T11276 and
WB27T11311 boards.

TRIM MADE IN UNITED STATES



WB27T11006CM
OVERLAY
12 button overlay.
Used with WB27T11276 and
WB27T11311 boards.

TRIM MADE IN UNITED STATES

COOKING



WB27T11229CM
OVERLAY
16 button black overlay.
Used with WB27T11162 and
WB27T11161 boards.

TRIM MADE IN UNITED STATES



WB27X11213CM
LIMIT THERMOSTAT
Closes at 158°F, Opens at 104°F.
Fits GE Microwaves.

THERMOSTAT MADE IN CHINA



WB28K10222CM
BURNER CAP
Medium 4.4" Diameter.
Fits GE Gas ranges.

TRIM MADE IN CHINA

COOKING



WB29K10023CM

BURNER CAP
Medium 3.2" Diameter. Fits GE Gas ranges.

TRIM

MADE IN CHINA



WB29K10024CM

BURNER CAP
Large 3.5" Diameter. Fits GE Gas ranges.

TRIM

MADE IN CHINA



WB2X7909CM

ANTI TIP KIT
Chain style anti tip bracket. Made for GE, but can be used on any range.

INSTALL

MADE IN CHINA

COOKING



WB2X8228CM

RANGE BLOCK (BAKELITE)
Includes block, bracket with 24" leads. Canada code compliant.

RECEPTACLE

MADE IN CHINA



WB2X9998CM

RANGE IGNITER
3.4-3.6 Amp, 1 1/2" block w/ double wing mount, 17" leads. Bake Igniter for single burner GE ranges.

IGNITER

MADE IN MEXICO



WB7X7183CM

HANDLE END CAP (BLACK)
Black oven door handle end-cap, fits both right and left side-short. Fits GE ranges.

TRIM

MADE IN CHINA

COOKING



WB7X7189CM

HANDLE END CAP (WHITE)
White oven door handle end-cap, fits both right and left side-short. Fits GE ranges.

TRIM

MADE IN CHINA

DISHWASHER



WD01X21740CM

COUNTER TOP BRACKET
Mounts GE under-counter dishwashers.

TRIM

MADE IN CHINA



WD08X23476CM

GASKET
Tub gasket. Fits GE Dishwashers.

GASKET

MADE IN CHINA

DISHWASHER



WD12X10074CM
ROLLER LOWER RACK
 Single Roller

TRIM

MADE IN CHINA



WD12X10267CM
STUD & ROLLER ASSEMBLY
 WD12X10074 roller, and stud assembly.

TRIM

MADE IN CHINA



WD12X10304CM
RACK SLIDE END CAP
 Upper rack roller stop. White

TRIM

MADE IN CHINA

DISHWASHER



WD12X10426CM
RACK STOP
 Top rail rack stops.
 Fits Whirlpool dishwashers.

TRIM

MADE IN CHINA



WD12X24058CM
DETERGENT DISPENSER
 13.5V DC solenoid, detergent and rinse cup assembly.
 Fits GE Artistry series Dishwasher.

MECHANICAL

MADE IN CHINA



WD12X24060CM
DETERGENT DISPENSER
 13.5V DC solenoid, detergent and rinse cup assembly.
 Fits GE Café series Dishwasher.

MECHANICAL

MADE IN CHINA

DISHWASHER



WD12X271CM
RACK ROLLER ASSEMBLY
 Roller and shaft assembly. White.

TRIM

MADE IN CHINA



WD15X10003CM
WATER VALVE
 120V, 60Hz with bracket.
 Fits GE under-counter dishwashers.

WATER VALVE

MADE IN MEXICO



WD15X10014CM
WATER VALVE
 Direct replacement with mounting bracket.
 Fits GE dishwashers.

WATER VALVE

MADE IN CHINA

DISHWASHER



WD15X10015CM

WATER VALVE

13.5V DC, with compression inlet.
Fits GE dishwashers.

WATER VALVE

MADE IN CHINA



WD15X22948CM

WATER VALVE

13.5V DC, 3/4" GHT inlet.
3/8" barb outlet.

WATER VALVE

MADE IN CHINA



WD15X24213CM

WATER VALVE

13.5V DC, with GHT inlet.
Fits GE dishwashers.

WATER VALVE

MADE IN CHINA

DISHWASHER



WD19X10032CM

IMPELLER ASSEMBLY

Impeller seal kit for WD26X10013
pumps. Fits GE Dishwashers.

PUMP

MADE IN CHINA



WD21X10060CM

SOLENOID (KIT)

Includes mounting brackets,
screws, and "E" ring. Fits GE built
dishwashers.

MECHANICAL

MADE IN CHINA



WD21X10268CM

SOLENOID ASSEMBLY

Fits GE dishwashers not requiring
drain feedback switch.

ELECTRICAL

MADE IN CHINA

DISHWASHER



WD21X10490CM

LATCH & SWITCH ASSEMBLY

Door latch and switch assembly.
Fits GE dishwashers.

SWITCH

MADE IN CHINA



WD21X25468CM

PRESSURE SENSOR

Sensor only, re-use original
mounting bracket. Fits GE
Dishwashers.

SWITCH

MADE IN ITALY



WD26X10013CM

WATER PUMP

Complete pump, motor and
solenoid. Fits GE dishwashers
since 1970.

PUMP

MADE IN CHINA

DISHWASHER



WD26X10051CM
PUMP MOTOR ASSEMBLY
115V, 1.5A, 3150RPM with pump
and capacitor.

MOTOR

MADE IN CHINA



WD26X10053CM
PUMP & MOTOR ASSEMBLY
115V, 60Hz, 1.5A, 3200RPM motor
pump assembly. Fits newer GE
dishwashers.

MOTOR

MADE IN CHINA



WD35X21038CM
STUD & ROLLER ASSEMBLY
Eight pack of WD12X10267CM.

TRIM

MADE IN CHINA

DISHWASHER



WD8X227CM
BAFFLE (RIGHT)
Right corner seal.
Fits GE dishwashers.

GASKET

MADE IN CHINA



WD8X228CM
BAFFLE (LEFT)
Left corner seal.
Fits GE dishwashers.

GASKET

MADE IN CHINA



WR57X77CM
WATER VALVE
120V, 60Hz, single coil valve.
Fits GE refrigerators with round
cube ice makers.

WATER VALVE

MADE IN UNITED STATES

DRYER



WE01X20374CM
TIMER KNOB
White timer knob.
"D" shaped shaft.

TRIM

MADE IN CHINA



WE01X20378CM
KNOB
2 1/8" diameter, light gray with
black pointer. Fits GE washers
and dryers.

TRIM

MADE IN CHINA



WE03X10016CM
ROLLER
Roller and shaft. Fits newer GE
large capacity dryers.

MECHANICAL

MADE IN CHINA

DRYER



WE03X23881CM

LINT SCREEN
13 1/2" wide x 6 1/4" tall.
Fits newer GE dryers.

SCREEN

MADE IN CHINA



WE04X28977CM

DOOR SWITCH
125/250V, 10A, 1/3HP, door switch.
Fits newer GE Dryers.

SWITCH

MADE IN CHINA



WE09X20441CM

FELT SEAL
3/16" x 9/16" x 52" drum felt. Fits GE dryers.

MECHANICAL

MADE IN CHINA

DRYER



WE12X20395CM

IDLER
2.29" diameter idler pulley. Fits newer GE dryers.

MECHANICAL

MADE IN CHINA



WE13X68KCM

DRUM GLIDE
Kit to repair WE13X68 Glides.
Includes felt, Teflon glide and rivets.

MECHANICAL

MADE IN CHINA



WE18X25100CM

LINT SCREEN
13 1/4" wide, white plastic.
Fits GE dryers.

SCREENS

MADE IN CHINA

DRYER



WE1M1067CM

BEARING GLIDE
2 1/16" x 5/8"
polytetrafluoroethylene.

MECHANICAL

MADE IN CHINA



WE1M333CM

SLID WH "S"
2 1/16" x 5/8". Polyethylene.

MECHANICAL

MADE IN CHINA



WE1M504CM

SLIDE
2 1/16" x 5/8" Polyethylene

MECHANICAL

MADE IN CHINA

DRYER



WE1M654CM

TIMER KNOB (WHITE)

White, ¼" D- Shaft, 2 ¾" diameter. Fits GE built dryers.

TRIM

MADE IN CHINA



WE1M964CM

KNOB

Dark Gray, ¼" D- Shaft, 2 ¾" diameter. Fits GE built dryers.

TRIM

MADE IN CHINA

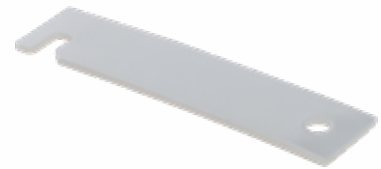

WE3M51CM

GLIDE (NYLON)

Nylon drum bearing glide. Fits GE Dryers.

MECHANICAL

MADE IN CHINA

DRYER

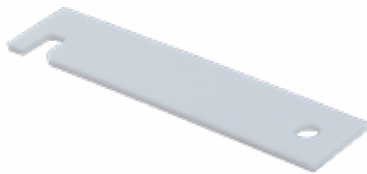

WE3M52CM

GLIDE (TEFLON)

Teflon drum bearing glide. Fits GE Dryers.

MECHANICAL

MADE IN CHINA



WE3X75CM

DRUM BEARING

Rear bearing only.

MECHANICAL

MADE IN CHINA



WE4M416CM

PTS SWITCH

125/250V, 50/60Hz, 15A, ½ HP. Fits GE dryers.

SWITCH

MADE IN CHINA

DRYER



WE4M519CM

ROTARY SWITCH

10A, ½ HP, 125VAC, 3 pole switch. Fits GE Dryers.

SWITCH

MADE IN CHINA

HVAC



WP12X10002CM

KNOB

1 ½" diameter, bisque. Fits GE Ptac units.

TRIM

MADE IN CHINA

**FIND MORE HVAC
STARTING PAGE 126**

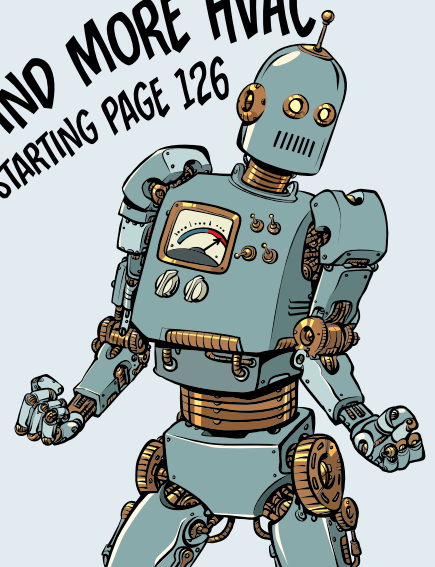

MICROWAVE



WB02X10700CM

ALUMINUM/CARBON FILTER
9 x 10 1/2" x 3/32" carbon filter.
Fits GE range hoods.

FILTER

MADE IN MEXICO



WB02X11096CM

DOOR LATCH
Latch and lever for oven door.
Fits GE over counter microwaves.

TRIM

MADE IN CHINA



WB02X11124CM

CHARCOAL FILTER
3 7/8" x 3 7/8" x 6 1/8" carbon filter.
Fits GE over counter microwaves.

FILTER

MADE IN MEXICO

MICROWAVE



WB02X11550CM

CHARCOAL FILTER
2 3/8" x 10 1/4" x 3/8" carbon filter.
Fits GE over counter microwaves.

FILTER

MADE IN UNITED STATES



WB02X32793CM

GREASE FILTER
5" x 7 5/8" x 3/32" aluminum grease
filter. Fits GE over the counter
microwaves.

FILTER

MADE IN MEXICO



WB02X35607CM

CHARCOAL FILTER
2 1/2" x 11" x 3/8" carbon filter.
Fits GE over counter microwaves.

FILTER

MADE IN MEXICO

MICROWAVE



WB03X27704CM

LOCKING BUTTON
Locking pin for waveguide
covers. Fits GE and other
microwaves.

TRIM

MADE IN CHINA



WB06X10596CM

GREASE FILTER
5 7/8" x 13 3/8" x 3/32" aluminum filter.
Fits GE over counter microwaves.

FILTER

MADE IN MEXICO

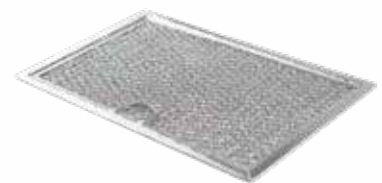

WB06X10608CM

GREASE FILTER
5 x 7 5/8" x 3/32" aluminum filter.
Fits GE over counter microwaves.

FILTER

MADE IN MEXICO

MICROWAVE



WB06X10625CM

TURNTABLE RING

Rotating ring with rollers.
Fits over counter GE microwaves.

TRIM

MADE IN CHINA



WB06X10638CM

WAVE GUIDE COVER

5" x 5" with tabs and cutout.
Fits GE over counter microwaves.

TRIM

MADE IN CHINA



WB10X10021CM

DOOR LATCH

Latch Pawl & spring.
Fits GE over counter microwaves.

TRIM

MADE IN CHINA

MICROWAVE



WB10X32782CM

DOOR LATCH

Latch and lever for oven door.
Fits GE over counter microwaves.

TRIM

MADE IN CHINA



WB15X10022CM

HANDLE (BLACK)

11" overall length, 8 3/4" screw
mount, glossy black finish.
Fits GE microwaves.

TRIM

MADE IN CHINA



WB15X10023CM

HANDLE (WHITE)

11" overall length, 8 3/4" screw
mount, glossy white finish.
Fits GE microwaves.

TRIM

MADE IN CHINA

MICROWAVE



WB26X10038CM

TURNTABLE MOTOR

21V AC, 50/60Hz, 2.5/3 RPM, 3.0W
with D shaft. Fits GE over range
microwaves.

MOTOR

MADE IN CHINA



WB27X11094CM

THERMOSTAT

TCO for oven cavity.
Fits over counter GE microwaves.

THERMOSTAT

MADE IN CHINA



WB2X8391CM

GREASE FILTER

9 x 10 1/2" x 3/32" aluminum filter.
Fits GE range hoods.

FILTER

MADE IN MEXICO

MICROWAVE



WB34X21271CM
WAVE GUIDE COVER
3" x 4".

Fits GE countertop microwaves.

TRIM

MADE IN CHINA



WB34X21610CM
WAVE GUIDE COVER
4" x 4" with mounting pin.

Fits GE over counter microwaves.

TRIM

MADE IN CHINA



WB39X10034CM
WAVE GUIDE COVER
3" x 4" with tabs.

Fits GE countertop microwaves.

TRIM

MADE IN CHINA

REFRIGERATOR

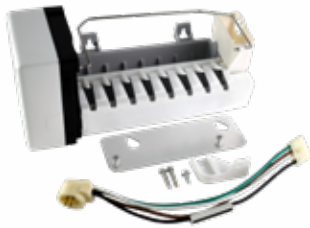

IM3CM
ICE MAKER

Designed to replace GE & Hotpoint, IM1 through IM3 series, used in thousands of models. Fits GE refrigerators.

ICE MAKERS

MADE IN CHINA



WR02X10585CM
SPRING

Dispenser flapper torsion spring. Fits GE SxS refrigerators.

MECHANICAL

MADE IN UNITED STATES



WR02X12650CM
SPRING

Mullion torsion spring. Fits GE french door models.

MECHANICAL

MADE IN UNITED STATES

REFRIGERATOR



WR09X20002CM
COLD CONTROL

120/240V, FLA8, LRA40 with 15" capillary. Fits GE top mount refrigerators.

THERMOSTAT

MADE IN CHINA



WR17X11653CM
CHUTE DOOR

Ice duct door and seal without crank arm. Fits GE SxS refrigerators.

MECHANICAL

MADE IN CHINA



WR17X11705CM
AUGER

14 3/8" long, metal shaft, plastic drives. Fits GE SxS refrigerators.

MECHANICAL

MADE IN CHINA

REFRIGERATOR



WR2X9144CM

END CAP

End mounting cap for fresh food door. Fits GE top mount refrigerators.

TRIM

MADE IN CHINA



WR2X9393CM

HEAT PROBE

Retro kit to supply heat from defrost element to drain. Fits GE refrigerators.

HEATER

MADE IN CHINA

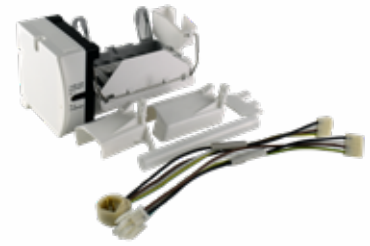

WR30X10093CM

ICE MAKER

Includes icemaker with hardwired harness connection, arm, and bracket. Fits GE refrigerators.

ICE MAKERS

MADE IN CHINA

REFRIGERATOR



WR30XUNI

ICE MAKER

Universal replacement GE Ice Maker, replaces both mechanical and electronic versions.

ICE MAKERS

MADE IN CHINA



WR50X10025CM

DEFROST THERMOSTAT

L50-30F, tube mount with 1x 15" lead and 1x 4 1/2" lead. Fits GE top mount refrigerators.

THERMOSTAT

MADE IN CHINA



WR50X10065CM

DEFROST THERMOSTAT

L140-30F tube mount with 10" stripped leads. Plastic housing. Fits GE SxS refrigerators.

THERMOSTAT

MADE IN CHINA

REFRIGERATOR



WR50X10068CM

DEFROST THERMOSTAT

120/250V, 5/10A, 140F open, 110F close. Fits GE SxS refrigerators.

THERMOSTAT

MADE IN CHINA



WR50X10069CM

DF THERMOSTAT

L140-30F tube mount with 10" stripped leads. Aluminum housing.

THERMOSTAT

MADE IN CHINA



WR50X10070CM

DF THERMOSTAT

Fits GE 18 CF refrigerators. Tube mount, 37TV31 series, L58-30F.

THERMOSTAT

MADE IN CHINA

REFRIGERATOR



WR50X10071CM

DF THERMOSTAT

Open: 64 Degree, Close: 23 Degree, 41 Degree Diff. Fits GE refrigerators.

THERMOSTAT

MADE IN CHINA



WR50X10073CM

DEFROST THERMOSTAT

L64-41F, with tube mount clips. Fits GE refrigerators.

THERMOSTAT

MADE IN CHINA

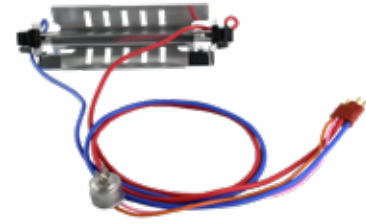

WR51X10031CM

DF HEATER

9 1/2" length, 115V, 575W. Fits GE refrigerators.

HEATER

MADE IN CHINA

REFRIGERATOR



WR51X10038CM

DEFROST HEATER

21" length, 115V, 375W. Fits GE refrigerators.

HEATER

MADE IN CHINA



WR51X10053CM

DEFROST HEATER

120V, 575W, 8" tube, 9 1/2" tube, dual glass w/o leads.

DF HEATER

MADE IN CHINA



WR51X10055CM

DEFROST HEATER

120V, 725W, 10 1/2" tube, 12" overall.

DF HEATER

MADE IN CHINA

REFRIGERATOR



WR51X10101CM

DEFROST HEATER

120V, 575W, 8" tube, 9 1/2" overall, dual tube with leads.

DF HEATER

MADE IN CHINA

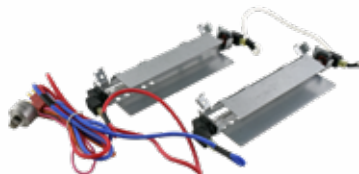

WR51X442CM

RADIANT DEFROST HEATER

115V, 600W, 9 1/2" overall, set of two with leads and thermostat

DF HEATER

MADE IN CHINA

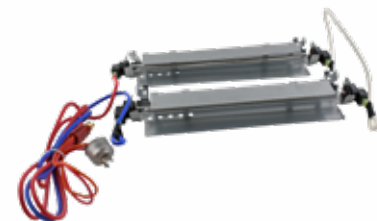

WR51X443CM

RADIANT DEFROST HEATER

155V, 772W, 12 13/16" overall, dual tube with harness and DF thermostat.

DF HEATER

MADE IN CHINA

REFRIGERATOR



WR55X10899CM

DISPLAY LIGHT BOARD
2 bulb, dispenser LED light. Fits GE SxS refrigerators.

SWITCH

MADE IN CHINA



WR55X11132CM

LED LIGHT
LED light and housing assembly. Fits GE SxS Refrigerators.

SWITCH

MADE IN CHINA



WR55X26671CM

LED LIGHT
LED 3 cluster light board. Fits GE SxS refrigerators.

SWITCH

MADE IN CHINA



WR55X32696CM

LED LIGHT BOARD
LED board with 12 lights, two pin connector. Fits GE SxS refrigerators.

SWITCH

MADE IN CHINA

REFRIGERATOR



WR55X10025CM

THERMISTOR
Includes 18" leads. Fits GE refrigerators.

THERMOSTAT

MADE IN CHINA



WR57X10023CM

WATER VALVE
Dual coil primary valve. Fits GE SxS models.

WATER VALVE

MADE IN CHINA



WR57X10024CM

WATER VALVE
Dual coil filter valve. Fits GE SxS models.

WATER VALVE

MADE IN CHINA

REFRIGERATOR



WR57X10026CM

WATER VALVE
WR57X10023 & WR57X10026 bracketed together. Fits GE SxS models.

WATER VALVE

MADE IN CHINA



WR57X10032CM

WATER VALVE
120V, 1/4" inlet-1/4" and 5/16" outlet all push connect. Fits GE SxS refrigerators.

WATER VALVE

MADE IN CHINA



WR57X10033CM

WATER VALVE
120V, 1/4" compression inlet-1/4" push connect outlet. Fits GE top mount refrigerators.

WATER VALVE

MADE IN CHINA

REFRIGERATOR



WR57X10051CM

WATER VALVE

120V, 1/4" compression inlet-1/4" and 5/16" push connect outlet. Fits GE SxS refrigerators.

WATER VALVE

MADE IN CHINA



WR60X10074CM

EVAPORATOR FAN MOTOR

9 3/4VDC, 3.25W, 1/8" shaft diameter. Fits GE refrigerators.

MOTOR

MADE IN CHINA



WR60X10141CM

EVAPORATOR FAN MOTOR

120V, 3W, 60Hz, 1/8" shaft diameter. Fits GE refrigerators.

MOTOR

MADE IN CHINA

REFRIGERATOR



WR60x10168CM

EVAPORATOR FAN MOTOR

115V .193A, 11W, 2200 RPM. Fits 14-18 CF top mount refrigerators.

MOTOR

MADE IN CHINA



WR60X10172CM

EVAPORATOR FAN MOTOR

115V, 7.4W, 1/8" shaft diameter. Fits GE refrigerators.

MOTOR

MADE IN CHINA



WR60X10185CM

EVAPORATOR FAN MOTOR

9 3/4VDC, 3 1/4W, 12" lead length. Fits GE refrigerators.

MOTOR

MADE IN CHINA

REFRIGERATOR



WR60X10204CM

FAN BLADE

4 1/2" diameter, 5 blade. Used in thousands of GE top freezer models.

MECHANICAL

MADE IN CHINA



WR60X10220CM

EVAPORATOR FAN MOTOR

115V 0.14A, 9W, 1750 RPM
Condenser motor for GE SxS refrigerators.

MOTOR

MADE IN CHINA



WR60X10257CM

EVAPORATOR FAN MOTOR

115V, 2.4W, 60Hz. Fits GE refrigerators.

MOTOR

MADE IN CHINA

REFRIGERATOR



WR60X10258CM
 AUGER MOTOR
 115V, 60Hz, 3.2 Amps.
 Fits GE SxS refrigerators.

MOTOR

MADE IN CHINA



WR60X10307CM
 EVAPORATOR FAN MOTOR
 9.75VDC, 3.5W, 6 pin connector.
 Fits GE SxS refrigerators.

MOTOR

MADE IN CHINA



WR60X10348CM
 CONDENSER MOTOR
 115VAC, 60Hz, 4.7W.
 Fits GE top mount refrigerators.

MOTOR

MADE IN ITALY

REFRIGERATOR



WR60X162CM
 EVAPORATOR FAN MOTOR
 120V, .16A, 11W, 60Hz, 3000 RPM.
 Fits GE built refrigerators.

MOTOR

MADE IN CHINA



WR60X21886CM
 EVAPORATOR FAN MOTOR
 115V, 60Hz, 0.11A, 6.7W, 2550 RPM. Fits GE built top mount refrigerators.

MOTOR

MADE IN CHINA



WR60X21887CM
 EVAPORATOR FAN MOTOR
 115V, 3.0W, 50/60Hz.
 Fits GE Top Mount refrigerators.

MOTOR

MADE IN CHINA

REFRIGERATOR



WR60X23584CM
 EVAPORATOR MOTOR
 115V, 60Hz, 3.3W with two pin connector. Fits GE top mount refrigerators.

MOTOR

MADE IN CHINA



WR60X25858CM
 EVAPORATOR MOTOR
 13.6VDC, 0.23A axial evaporator fan motor. Fits GE bottom mount refrigerators.

MOTOR

MADE IN VIETNAM



WR60X30922CM
 FAN BLADE
 4.3" Diameter, 3 blade for evaporator motor. Fits GE SxS refrigerators.

MECHANICAL

MADE IN CHINA

REFRIGERATOR



WR60X31522CM

EVAPORATOR MOTOR

115V-60Hz, 3.3W with two pin connector plus ground wire. Fits GE top mount refrigerators.

MOTOR

MADE IN CHINA



WR62X10055CM

DISPENSER SOLENOID

115V, 1.15A, 60Hz, 13.5W coil with actuator. Fits GE refrigerators.

MECHANICAL

MADE IN CHINA



WR9X10041CM

DEFROST TIMER

120V, 50/60Hz, 12 Hour, 33 Minute. 10 Amp, 1/2 HP.

ELECTRICAL

MADE IN CHINA

REFRIGERATOR



WR9X480CM

DEFROST TIMER

120V, 60Hz, 10A, 6 Hour 30 Minute. Fits GE refrigerators.

ELECTRICAL

MADE IN CHINA



WR9X483CM

DEFROST TIMER

120V, 50/60 Hz, 10A, 1/3 HP, 10 Hour, 30 Minute. Fits GE top mount refrigerators.

ELECTRICAL

MADE IN CHINA



WR9X502CM

DEFROST TIMER

120V, 60Hz, 10A, 6 Hour 25 Minute. Fits GE refrigerators.

MECHANICAL

MADE IN CHINA

WASHER



WE01X20378CM

KNOB (LIGHT GRAY)

2 1/8" diameter, light gray with black pointer. Fits GE washers and dryers.

SWITCH

MADE IN CHINA



WH01X10061CM

TIMER KNOB (WHITE)

White, timer knob. Fits GE built washing machines.

SWITCH

MADE IN CHINA



WH01X10310CM

TIMER KNOB (WHITE)

White, timer knob. Fits GE built washing machines.

SWITCH

MADE IN CHINA



WH01X10462CM

TIMER KNOB (GRAY)

Gray, timer knob. Fits GE dryers and washing machines.

SWITCH

MADE IN CHINA

WASHER



WH01X24434CM

SPRING

Spring for shifter clutch. Fits newer GE top load washers.

MECHANICAL

MADE IN CHINA



WH03X30517CM

ACTUATOR

Mode shifter assembly. Fits newer GE top-load washers.

MECHANICAL

MADE IN CHINA



WH05X24185CM

CLUTCH

Shift clutch. Fits newer GE washers.

MECHANICAL

MADE IN CHINA

WASHER



WH08X24594CM

TUB SEAL

Transmission shaft to tub seal. Fits GE top load laundry centers.

MECHANICAL

MADE IN CHINA



WH08X32657CM

LID LOCK (SWITCH ONLY)

120V, 50/60Hz lid lock switch. Fits GE top load washers.

SWITCH

MADE IN CHINA



WH08X32697CM

LID LOCK

Service kits includes WH08x32657 switch, bezels and strike. Fits GE top load washers.

SWITCH

MADE IN CHINA

WASHER



WH12X10068CM

PRESSURE SWITCH

125V, 12A, 1/2HP, 3 terminal with mounting bracket. Fits GE top load washers.

SWITCH

MADE IN CHINA



WH12X10069CM

PRESSURE SWITCH

125V, 12A, 1/2HP, 3 Terminal with mounting bracket. Fits GE top load washers.

SWITCH

MADE IN CHINA



WH12X10076CM

PRESSURE SWITCH

125V, 12A, 1/2HP, 3 Terminal with mounting bracket. Fits GE top load washers.

SWITCH

MADE IN CHINA



WH12X10108CM

PRESSURE SWITCH

125V, 12A, 1/2HP, 3 Terminal with mounting bracket. Fits GE top load washers.

SWITCH

MADE IN CHINA

WASHER



WH12X10173CM

PRESSURE SWITCH
125V, 12A, ½HP, 3 Terminal
with mounting bracket.
Fits GE top load washers.

SWITCH

MADE IN CHINA



WH12X10311CM

PRESSURE SWITCH
125V, 12A, ½HP, 3 Terminal
with mounting bracket.
Fits GE top load washers.

SWITCH

MADE IN CHINA



WH12X10321CM

PRESSURE SWITCH
125V, 12A, ½HP, 3 Terminal
with mounting bracket.
Fits GE top load washers.

SWITCH

MADE IN CHINA



WH12X10413CM

PRESSURE SWITCH
125V, 12A, ½HP, 3 Terminal
with mounting bracket.
Fits GE top load washers.

SWITCH

MADE IN CHINA

WASHER



WH12X10412CM

PRESSURE SWITCH
125V, 12A, ½HP, 4 Terminal.
Fits GE top load washers.

SWITCH

MADE IN CHINA



WH12X10476CM

PRESSURE SWITCH
125V, 12A, ½HP, 3 terminal with
mounting bracket. Fits GE top
load washers.

SWITCH

MADE IN CHINA



WH12X10479CM

PRESSURE SWITCH
125V, 12A, ½HP, 3 terminal with
mounting bracket. Fits GE top
load washers.

SWITCH

MADE IN CHINA

WASHER



WH12X10530CM

PRESSURE SWITCH
Pressure switch with snap tab
mounting. Fits GE laundry center.

SWITCH

MADE IN CHINA



WH12X1075CM

WATER VALVE
220/240V 50 Hz, two coil with
center blank. Fits GE top load
washers.

WATER VALVE

MADE IN CHINA



WH13X10024CM

WATER VALVE
2 coil ½" outlet with ear mounts-
Blue body. Fits GE top load
washers.

WATER VALVE

MADE IN CHINA

WASHER



WH13X10025CM

WATER VALVE
120V, 60Hz, three coil valve w/3 temp thermistor. Fits GE top load washers.

WATER VALVE MADE IN CHINA



WH13X10026CM

WATER VALVE
120V, 60Hz, three coil valve w/3 temp thermistor. Fits GE top load washers.

WATER VALVE MADE IN CHINA



WH13X10027CM

WATER VALVE
120V, 60Hz, three coil valve w/4 temp thermistor. Fits GE top load washers.

SWITCH MADE IN CHINA



WH13X10029CM

WATER VALVE
1 double, 1 single valves on mounting bracket. Fits GE front load machines.

SWITCH MADE IN CHINA

WASHER



WH13X10033CM

WATER VALVE
120V, 60Hz dual coil with center blank. 4-pin thermistor plug. Fits GE top load washers.

WATER VALVE MADE IN ITALY



WH13X10037CM

WATER VALVE
2 coil 1/2" outlet with ear mounts, blank center coil. Fits GE top load washers.

WATER VALVE MADE IN CHINA



WH13X10053CM

WATER VALVE
120V, 60Hz, two coil valve with center blank. Fits GE top load washers.

WATER VALVE MADE IN CHINA



WH13X10059CM

WATER VALVE
120V, 60Hz, six coil valve. Fits GE top load washers.

WATER VALVE MADE IN CHINA

WASHER



WH13X10066CM

WATER VALVE
120V, 60Hz, three coil valve. Fits GE front load washers.

WATER VALVE MADE IN CHINA



WH23X10028CM

WATER PUMP
Fits GE front load washers.

PUMP MADE IN CHINA



WH13X23974CM

WATER VALVE
120V, 60Hz, two coil valve with center blank. Fits GE top load washers.

WATER VALVE MADE IN CHINA

WASHER



WH13X26534CM

WATER VALVE

120V, two coil with diffuser outlet.
Fits GE top load washers.

WATER VALVE

MADE IN CHINA



WH13X26535CM

WATER VALVE

120V, two coil with diffuser outlet.
Fits GE top load washers.

WATER VALVE

MADE IN CHINA



WH23X10030CM

PUMP - WASHER

Complete assembly with
mounting bracket.
Fits newer top load washers.

PUMP

MADE IN CHINA

WASHER



WH23X24178CM

WATER PUMP

120V, 60Hz, 1 1/4 Amp, 10 min on, 50
min off.
Fits GE front load washers.

PUMP

MADE IN CHINA



WH23X27419CM

WATER PUMP

110/115V, 60Hz, 30W Drain Pump
Fits newer GE top load washers.

PUMP

MADE IN CHINA



WH44X10288CM

LID LOCK SWITCH

120V, 60Hz, lid lock and switch
assembly.
Fits GE laundry center.

SWITCH

MADE IN CHINA

WASHER



WH49X10042CM

AGITATE COUPLING

Agitator drive bell.
Fits newer top load washers.

MECHANICAL

MADE IN CHINA



WH2X10032CM

SEAL

Outer tub seal.
Fits newer top load washers.

PUMP

MADE IN CHINA



MAT1

DP1 & DP2 COUNTER MAT

Ultra-heavy duty plastic top with
premium extra thick 3/16" foam
backing. Includes DP1 & DP2
Reference Guide graphic.

MARKETING

COOKING



EAU61865301CM
CONVECTION MOTOR
 120V, 60Hz, 17W Convection motor. Fits LG electric ranges.

TRIM

MADE IN CHINA



EAU61865302CM
CONVECTION MOTOR
 120V, 60Hz, 17W Convection motor. Fits LG electric ranges.

TRIM

MADE IN CHINA

DISHWASHER



4581DD3002ACM
ROLLER (UPPER RACK)
 Upper rack roller for LG & Kenmore Elite dishwashers. Includes roller and clip on axel.

TRIM

MADE IN CHINA

DISHWASHER



4581DD3003BCM
ROLLER (LOWER RACK)
 Lower rack roller for LG & Kenmore Elite dishwashers. Includes roller and clip on axel.

TRIM

MADE IN CHINA



4933DD3001BCM
DISHWASHER CABLE
 Connects door hinge to spring. Fits LG and Kenmore dishwashers.

MECHANICAL

MADE IN CHINA



AJU33450701CM
WATER VALVE
 110V, dual coil. Fits LG dishwashers.

WATER VALVE

MADE IN CHINA

DRYER



4027EL1001ACM
DOOR CATCH
 Latch and catch assembly. Fits LG and Kenmore dryers.

MECHANICAL

MADE IN CHINA



4560EL3001ACM
IDLER PULLEY
 Self lubricating pressed bearing. Fits LG and Kenmore dryers.

MECHANICAL

MADE IN CHINA



4561EL3002ACM
IDLER ARM
 Includes roller, shaft, bracket and spring. Fits LG dryers.

MECHANICAL

MADE IN CHINA

DRYER



4581EL2002CCM
ROLLER AND SHAFT ASSEMBLY
Heavy duty roller and shaft assembly. Includes tri-rings.

MECHANICAL

MADE IN CHINA



4581EL2002HCM
ROLLER W/ BALL BEARING
Roller and shaft with ball bearings. Fits LG dryers.

MECHANICAL

MADE IN CHINA



4681EL1008ACM
MOTOR
1/3 HP, 120V/60 Hz.
Thermally protected.

MOTOR

MADE IN CHINA

DRYER



5231EL1001CCM
LINT FILTER
Filter with felt seal attached. Fits LG and Kenmore dryers.

SWITCH

MADE IN CHINA



5231EL1002ECM
LINT SCREEN
Improved wire mesh and center support prevents tear. Fits LG and Kenmore dryers.

SWITCH

MADE IN CHINA



5835EL1002ACM
BLOWER WHEEL
7 5/8" Diameter, accepts 1/2" shaft.

SWITCH

MADE IN CHINA



6323EL2001BCM
THERMISTOR
10K Ohms @ 77F
Fits LG, GE and Kenmore dryers.

SWITCH

MADE IN CHINA

DRYER



6601EL3001ACM
DOOR SWITCH
7.5A, 125V/5A 250V AC 1/3H
Fits LG and Kenmore dryers.

SWITCH

MADE IN CHINA



6931EL3002MCM
THERMOSTAT
85C, 185F, thermal fuse Mounts on blower housing.

THERMOSTAT

MADE IN CHINA



6931EL3003CM
THERMOSTAT (HIGH LIMIT)
110C/240F Resettable.
Fits LG and Kenmore dryers.

THERMOSTAT

MADE IN CHINA

DRYER



6931EL3003DCM

THERMOSTAT
140C/284F Fixed.
Fits LG and Kenmore dryers.

THERMOSTAT

MADE IN CHINA



6931EL3004BCM

THERMOSTAT
L203-59, thermostat.
Mounts on burner tube.

THERMOSTAT

MADE IN CHINA



ADQ56656401CM

LINT SCREEN
12" W x 11" T, plastic screen.
Fits LG and Kenmore dryers.

SCREENS

MADE IN CHINA

DRYER



LGKIT

REBUILD KIT
Kit includes 4 drum rollers, idler pulley and 4 rib belt.
Fits LG Dryers.

MECHANICAL

MADE IN CHINA



LGKITHD

HD DRYER REBUILD KIT
Kit includes 4 drum rollers w/ball bearings, idler pulley and 5 rib belt.
Fits LG Dryers.

MECHANICAL

MADE IN CHINA

MICROWAVE



5230W1A012ECM

GREASE FILTER
5 x 7 5/8" x 3/32" aluminum filter.
Fits LG over counter microwaves.

FILTER

MADE IN MEXICO

REFRIGERATOR



4681JB1029BCM

EVAPORATOR MOTOR
13Vdc, 1.55W, 120mA, CCW.
Fits LG refrigerators.

MOTOR

MADE IN SOUTH KOREA



5221JA2006DCM

WATER VALVE
110V three coil, dual valve connected with bracket.
Fits LG refrigerators.

WATER VALVE

MADE IN CHINA



6500JB2002XCM

THERMISTOR
1 3/8" bulb with 11" lead with disconnect plug.
Fits LG bottom mount refrigerators.

THERMISTOR

MADE IN CHINA

REFRIGERATOR



6600JB1010ACM

LIGHT SWITCH

1 Amp @ 125V, 0.5 Amp @ 250V.
Fits LG and Kenmore refrigerators.

SWITCH

MADE IN CHINA



ACQ73244001CM

THERMISTOR

1 3/8 bulb with 28 1/2" lead with disconnect plug and mounting housing.

THERMOSTAT

MADE IN CHINA



AEQ72909603CM

ICE MAKER

12 cube, flex tray design. Fits LG and Kenmore bottom freezers.

ICE MAKERS

MADE IN CHINA

REFRIGERATOR



AJU72992601CM

WATER VALVE

Single coil with thermistor and wire harness. Fits LG refrigerators.

WATER VALVE

MADE IN CHINA



EAU61524007CM

EVAPORATOR FAN MOTOR

13VDC 0.13A, 1.7W.

Fits LG SxS refrigerators.

MOTOR

MADE IN CHINA



EAU61644105CM

EVAPORATOR MOTOR

13V, 120mA, CCW.

Fits LG refrigerators.

MOTOR

MADE IN SOUTH KOREA

REFRIGERATOR



MJX41869202CM

WATER VALVE

110V single coil valve with 2 quick connect outlets.
Fits LG refrigerators.

WATER VALVE

MADE IN CHINA

WASHER



4036ER2004ACM

WASHER TUB SEAL

Forms a water tight seal between tub and spin shaft. Sits in front of bearings.

MECHANICAL

MADE IN CHINA



4036ER4001BCM

OUTER TUB SEAL

Seals between front and rear tub halves. Fits LG and Kenmore front load washers.

MECHANICAL

MADE IN CHINA

WASHER



4280EN4001CCM

WASHER BEARING

Supports the spin shaft through the tub. Front Bearing.

MECHANICAL

MADE IN CHINA



4280FR4048ECM

BEARING

Supports the spin shaft through the tub. Back Bearing.

MECHANICAL

MADE IN CHINA



4681EA1007GCM

PUMP - WASHER

120 V, 80W

Fits LG and Kenmore front load washer.

PUMP

MADE IN CHINA

WASHER



4681EA2001TCM

PUMP - WASHER

120 V, 80W

Fits LG and Kenmore front load washer.

PUMP

MADE IN CHINA



4681EA2002HCM

DRAIN PUMP

120V, 30W

Fits washers and dishwashers.

MECHANICAL

MADE IN CHINA



4738ER1002ACM

HOSE

Tub to pump hose.

Fits LG and Kenmore front load washers.

MECHANICAL

MADE IN CHINA

WASHER

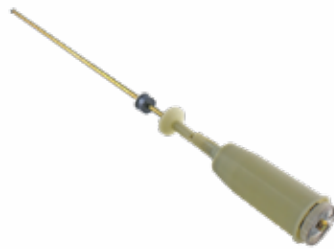

4902FA1665WCM

SUSPENSION ROD

25" length, complete stability rod assembly. Fits LG top load washers.

MECHANICAL

MADE IN CHINA



5220FR2006HCM

WATER VALVE

Single solenoid valve for hot water. Fits LG front load machines.

WATER VALVE

MADE IN CHINA



5220FR2008CCM

WATER VALVE

120V, 60Hz, four coil cold water valve. Fits LG top load washers. Discontinued by OEM.

WATER VALVE

MADE IN CHINA

WASHER



5220FR2008ECM

WATER VALVE
Four Coil, 120V 60 Hz.
Fits LG and Kenmore
front load washers.

WATER VALVE MADE IN CHINA



5220FR2008FCM

WATER VALVE
Four solenoid valve for
cold water. Fits LG front
load washers.

WATER VALVE MADE IN CHINA



5220FR2075CCM

WATER VALVE
Three solenoid valve for
cold water. Fits LG front
load washers.

WATER VALVE MADE IN CHINA



5220FR2075LCM

WATER VALVE
Three solenoid valve for
cold water. Fits LG front
load washers.

WATER VALVE MADE IN CHINA

WASHER



5221EA1009BCM

WATER VALVE
110V, 5 coil inlet valve.
Fits LG front load washers.

WATER VALVE MADE IN CHINA



5221EA2001CCM

WATER VALVE
110V, two coil linear valve.
Fits LG washers.

WATER VALVE MADE IN CHINA



5301EL1001JCM

HEATING ELEMENT
240V, 5400W complete assembly
with housing and thermostats.

ELEMENT MADE IN CHINA

WASHER



6322FR2046CCM

TEMPERATURE SENSOR
Monitors water temperature.
Fits LG and Kenmore washers.

MECHANICAL MADE IN CHINA



6500EL3001ACM

MOISTURE SENSOR
Detects moisture in laundry for
auto dry. 6 1/2" long with 1/4" spade
terminals.

MECHANICAL MADE IN CHINA



6501KW2002ACM

ROTOR POSITION SENSOR
Mounts on motor to sense load
and rotor position. Fits LG and
Kenmore front load washers.

MECHANICAL MADE IN CHINA

WASHER



6601ER1006ECM

PRESSURE SWITCH
120V, 3 Pin connector.
Fits LG and Kenmore front load washers.

SWITCH

MADE IN CHINA



AGM73269501CM

FILTER 1x BLUE, 1x ORANGE W/HANDLE
Plastic screen replacement inserts for water valves.
Fits LG Washers.

COMPONENT

MADE IN CHINA



AJU73213301CM

WATER VALVE
12V DC, five coil valve.
Fits LG top load washers.

WATER VALVE

MADE IN CHINA

WASHER



EAU61383503CM

WATER PUMP
120V, 60Hz, 0.75A.
Fits LG front load machines.

PUMP

MADE IN CHINA



EBF49827801CM

DOOR LOCK
120V, 60Hz, lid lock and switch assembly. Fits LG front load washers with front control panel.

SWITCH

MADE IN CHINA



EBF61315802CM

DOOR LOCK
120V, 60Hz, lid lock and switch assembly. Fits LG front load washers with top control panel.

SWITCH

MADE IN CHINA

PARTS DESIGNED FOR TECHNICIANS



SAMSUNG

COOKING

IMAGE	PART NUMBER	SWITCH TYPE	BUTTONS	COLOR	DETAILS
	DG34-00017ACM	Membrane	Thirty	Black	Used with DE92-02588C controllers
	DG34-00020ACM	Membrane	Thirty-two	Black	Used with DE91-03045H controllers
	DG34-00025ACM	Membrane	Twenty-two	Black	Used with DE92-02588G controllers
	DG34-00027BCM	Membrane	Twenty-two	Black	Used with DE92-02588G controllers
	DG34-00030ACM	Membrane	Thirty	Black	Used on free standing electric glass top range

ELECTRICAL

ALL OF OUR MEMBRANE SWITCHES USE PREMIUM 3M ADHESIVE BACKING.

MADE IN UNITED STATES



COOKING



DG31-00005ACM

CONVECTION MOTOR

120V, 60 Hz, oven convection motor. Fits Samsung convection motor.

MOTOR

MADE IN CHINA



DG44-01002ACM

INFINITE SWITCH

15A, 240V. Fits Samsung ceramic element

SWITCH

MADE IN MEXICO



DG44-01008ACM

INFINITE SWITCH

240V, 15A. Fits Samsung ranges.

SWITCH

MADE IN CROATIA



COOKING



DG44-01009ACM

INFINITE SWITCH

240V, 1250W, 4.4-5.8A for 6" element. Fits Samsung ranges.

SWITCH

MADE IN MEXICO

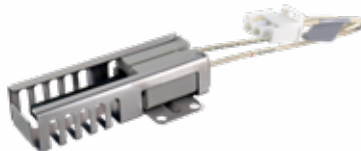

DG94-00520ACM

RANGE IGNITER

3.4-3.6 Amp, 1 1/2" block, 3 3/4" cage, 8" leads with female pins. Fits Samsung gas ranges.

IGNITER

MADE IN MEXICO



DG96-00110ECM

CONVECTION MOTOR

120V, 60Hz, 31W Convection motor with mounting plate. Fits Samsung electric ranges.

MOTOR

MADE IN CHINA



DISHWASHER

**DC31-00187ACM**

DRAIN PUMP
120V, 60 Hz, 80W.
Fits Samsung dishwashers.

MOTOR

MADE IN CHINA

**DC62-30314LCM**

WATER VALVE
120V, 60Hz, single coil valve
with GHT inlet. Fits Samsung
dishwashers.

WATER VALVE

MADE IN CHINA

**DD33-01002ACM**

WATER VALVE
120V, 60Hz, 3/4" GHT inlet, and 1/16"
outlet with rubber sleeve.
Fits Samsung Dishwashers.

WATER VALVE

MADE IN ITALY

DISHWASHER

**DD62-00084ACM**

WATER VALVE
120V, 60Hz, single coil valve with
compression inlet.
Fits Samsung dishwashers.

WATER VALVE

MADE IN CHINA

**DD66-00023ACM**

LOWER RACK ROLLER
Lower rack roller for Samsung
dishwasher. Includes roller and
clip on axel.

TRIM

MADE IN CHINA

**DD81-02132ACM**

DOOR SWITCH
125V, 10A, 1/2HP micro switch
mounted into latch housing.
Fits Samsung dishwashers.

SWITCH

MADE IN CHINA

DISHWASHER

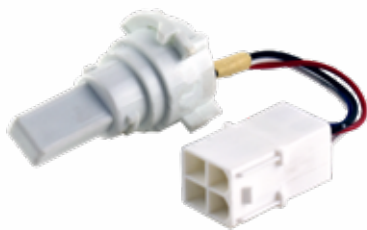
**DD82-01118ACM**

ECS SENSOR
Monitors water temperature and
sends signal back to the control
board. Fits Samsung dishwashers.

SENSOR

MADE IN CHINA

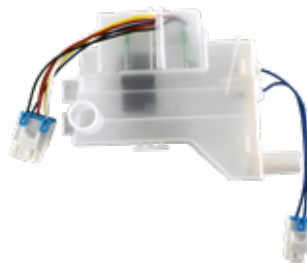
**DD94-01006ACM**

SENSOR
Monitors incoming water.
Fits Samsung dishwashers.

THERMOSTAT

MADE IN CHINA

**DC31-00055DCM**

MOTOR
120V, 60 Hz, 6.2 Amp, 1725 RPM
Fits Samsung and Kenmore
dryers.

MOTOR

MADE IN CHINA

SAMSUNG

DRYER



DC31-00055HCM

MOTOR

120V, 60 Hz, 6.2 Amp, 1725 RPM
Fits Samsung and Kenmore dryers.

MOTOR

MADE IN CHINA



DC32-00007ACM

THERMISTOR

10K Ohms @ 77 F
Fits Samsung, Whirlpool, and Kenmore dryers.

THERMOSTAT

MADE IN CHINA



DC47-00016ACM

THERMAL FUSE

125/250V, 25A, 85C-35C. 185F.
Fits Samsung, Whirlpool and Kenmore dryers.

THERMAL

MADE IN CHINA

DRYER



DC47-00018ACM

THERMOSTAT

L260-50F. 125/250V. 25A. 1/4" spade terminals. Used on DC97-14486A elements.

THERMOSTAT

MADE IN CHINA

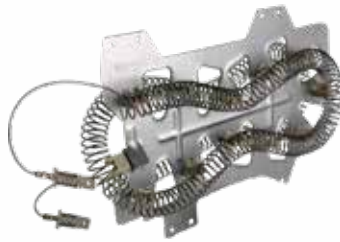

DC47-00019ACM

19A ELEMENT

240V, 5300W
Element only for DC97-14486A.

ELEMENT

MADE IN CHINA



DC47-00022ACM

IGNITER

3.4 - 3.6 Amps, 2" wide block.
Fits Samsung Dryers.

IGNITER

MADE IN MEXICO

DRYER



DC47-00032ACM

32A ELEMENT

240V, 3700W
Coil only for DC93-00154A.
Fits newer Samsung dryers.

ELEMENT

MADE IN CHINA



DC61-01215BCM

IDLER SPRING

Idler tension spring.
Fits Samsung and Kenmore dryers.

MECHANICAL

MADE IN CHINA



DC61-02595ACM

LINT SCREEN

Case type lint filter.
Fits Samsung dryers.

TRIM

MADE IN CHINA

DRYER



DC61-02610ACM

LINT FILTER FLAPPER

Flapper for DC97-16013A, DC97-16742A and DC61-02613A filters.

TRIM

MADE IN CHINA



DC61-02613ACM

LINT SCREEN

Approximately 11" T x 13" W
Gray molded plastic.

TRIM

MADE IN CHINA



DC61-03128ACM

LEVEL LEG

1.875" T x 0.95" Gray screw in leg.
Fits Samsung dryers.

TRIM

MADE IN CHINA

DRYER



DC64-00828ACM

DOOR SWITCH

5A, 250V

Fits Samsung and Kenmore dryers.

SWITCH

MADE IN CHINA



DC93-00154ACM

HEATING ELEMENT

240V, 3700W, 3 terminal.

Complete with canister and thermostats. Fits Samsung dryer.

ELEMENT

MADE IN MEXICO



SEE PAGE 10



DC93-00634ACM

IDLER ARM WITH BALL BEARING

New heavy duty style with ball bearing. Fits Samsung dryers.

MECHANICAL

MADE IN CHINA

DRYER



DC96-00882CCM

IDLER ARM REPLACES

Pulley and bracket assembly.
Fits Samsung, Whirlpool and Kenmore dryers.

MECHANICAL

MADE IN CHINA



DC96-00887ACM

THERMAL FUSE

250V, 160C, -35C. 320F.

Fits Samsung, Whirlpool and Kenmore dryers.

THERMOSTAT

MADE IN CHINA



DC97-12150ACM

LEG

Includes Leg and mounting bracket. Fits Samsung and Kenmore dryers.

MECHANICAL

MADE IN CHINA

SAMSUNG

DRYER



DC97-14486ACM

19A ELEMENT
240V, 5300W

Complete assembly with housing.

ELEMENT

MADE IN CHINA



DC97-16013ACM

LINT FILTER

Lint filter with curved top and flapper. Fits Samsung dryers.

TRIM

MADE IN CHINA



DC97-16742ACM

LINT FILTER

Lint filter with screen cover. Fits Samsung dryers.

TRIM

MADE IN CHINA

DRYER



DC97-16782ACM

ROLLER AND SHAFT
ASSEMBLY

Includes roller, shaft and tri-rings. Fits Samsung and Kenmore dryers.

MECHANICAL

MADE IN CHINA



SEE PAGE 10



DC97-16782ECM

DRUM ROLLER
W/ BALL BEARING

Heavy duty drum roller and shaft assembly with ball bearing. Upgrade from DC97-16782A sleeve bearing version.

MECHANICAL

MADE IN CHINA



SAMKIT

REBUILD KIT

Kit includes 4 drum rollers, idler pulley and belt. Fits Samsung Dryers.

MECHANICAL

MADE IN CHINA



SAMKITHD

REBUILD KIT

Kit includes 4 drum rollers, idler pulley and belt. Upgrade to ball bearing rollers and idler. Fits Samsung Dryers.

MECHANICAL

MADE IN CHINA



SEE PAGE 10

MICROWAVE



DE47-20034ACM

THERMOSTAT

Thermal cutout. Fits Samsung over counter microwaves.

THERMOSTAT

MADE IN CHINA



DE63-00196ACM

GREASE FILTER

5 7/8" x 13 3/8" x 3/32" aluminum grease filter. Fits Samsung over the counter microwaves.

FILTER

MADE IN MEXICO



DE63-00666ACM

GREASE FILTER

6 11/32" x 6 13/16" x 3/32" aluminum grease filter. Fits Samsung over the counter microwaves.

FILTER

MADE IN MEXICO

MICROWAVE

**DE63-30016GCM****CARBON FILTER**

4" x 8 3/4" x 3/8" carbon filter.
Fits Samsung over the counter microwaves.

FILTER

MADE IN MEXICO

**DE63-30016HCM****CHARCOAL FILTER**

3 7/8" x 6 1/8" x 3/8" carbon filter.
Fits Samsung over counter microwaves.

FILTER

MADE IN MEXICO

**DE91-70063DCM****DIODE**

High voltage diode with spade connector and ring terminal.
Fits Samsung microwaves.

ELECTRICAL

MADE IN CHINA

REFRIGERATOR

**DA31-00020ECM****EVAPORATOR FAN MOTOR**

12VDC, 3.48W, 0.29A,
2770 RPM.

Fits Samsung french door refrigerators.

MOTOR

MADE IN CHINA

**DA31-00146BCM****EVAPORATOR FAN MOTOR**

12VDC, 0.24A, 2/82W,
1600RPM.

Fits Samsung bottom mount refrigerators.

MOTOR

MADE IN CHINA

**DA31-00146ECM****EVAPORATOR FAN MOTOR**

12VDC, 0.27A, 3.21W,
2520RPM.

Fits Samsung refrigerators.

MECHANICAL

MADE IN CHINA

**DA31-00146JCM****EVAPORATOR FAN MOTOR**

2.8W 0.265A, 1800 RPM,
12VDC E-Class. Fits

Samsung and Kenmore SxS refrigerators.

MECHANICAL

MADE IN CHINA

REFRIGERATOR

**DA31-00070ECM****ICE ROOM MOTOR**

12VDC, 0.10A motor.

Fits in auger motor assembly.
Fits Samsung refrigerators.

MOTOR

MADE IN CHINA

**DA31-00334CCM****EVAPORATOR FAN MOTOR**

12VDC evaporator fan motor assembly. Fits Samsung bottom mount refrigerators.

MOTOR

MADE IN CHINA

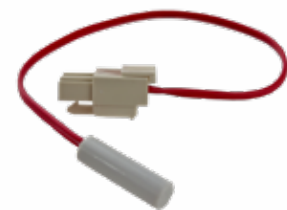
**DA32-00006RCM****PANTRY DRAWER THERMISTOR**

1" probe, 8 3/8" lead with two pin connectors. Fits Samsung bottom mount refrigerators.

THERMOSTAT

MADE IN CHINA

SAMSUNG

REFRIGERATOR



DA32-00006SCM

REFRIGERATOR DEFROST SENSOR
1" probe, 16" insulated lead with two pin connectors. Fits Samsung bottom mount refrigerators.

THERMOSTAT

MADE IN CHINA

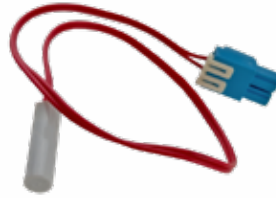

DA32-00011CCM

REFRIGERATOR SENSOR
1" probe, 12" lead with two pin connectors. Fits Samsung refrigerators.

THERMOSTAT

MADE IN CHINA



DA32-00024WCM

REFRIGERATOR SENSOR
1" probe, 16" insulated lead with two pin connectors. Fits Samsung bottom mount refrigerators.

THERMOSTAT

MADE IN CHINA

REFRIGERATOR



DA32-00029QCM

THERMISTOR
1" Bulb with 5 1/2" lead with quick disconnect plug. Fits Samsung SxS refrigerators.

THERMISTOR

MADE IN CHINA



DA32-10104NCM

THERMISTOR
1" bulb, 9 1/2" overall. Fits Samsung SxS refrigerators.

THERMISTOR

MADE IN CHINA



DA32-10105RCM

DEFROST SENSOR
1" probe, 25 3/4" lead with two pin connectors. Fits Samsung refrigerators.

THERMOSTAT

MADE IN CHINA

REFRIGERATOR

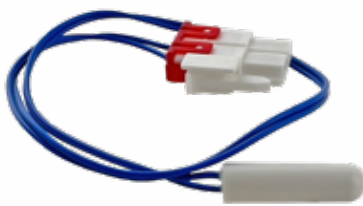

DA32-10105VCM

REFRIGERATOR SENSOR
1" probe, 11 1/2" lead with two pin connectors. Fits Samsung SxS refrigerators.

THERMOSTAT

MADE IN CHINA



DA32-10105XCM

THERMISTOR
1" Bulb with 18 3/4" lead with quick disconnect plug. Fits Samsung SxS refrigerators.

THERMISTOR

MADE IN CHINA



DA32-10109WCM

REFRIGERATOR SENSOR
1" probe, 10" lead with two pin connectors. Fits Samsung SxS refrigerators.

THERMOSTAT

MADE IN CHINA

REFRIGERATOR

**DA47-00243KCM**

DEFROST THERMOSTAT
L60-40F, button mount with two blade connector block.
Fits Samsung french door refrigerators.

THERMOSTAT

MADE IN CHINA

**DA59-00294BCM**

ICE MAKER MODULE
Ice maker module with 8 pin connector. Used in DA97-05037D and DA97-07603B ice maker.

ICE MAKERS

MADE IN CHINA

**DA61-05435ACM**

ICE GUIDE
6 5/8" long, ice sensing arm.
Fits DA97-13718C and DA97-15217D ice makers.

COMPONENT

MADE IN CHINA

REFRIGERATOR

**DA47-00244DCM**

DEFROST HEATER
115V, 120W element.
Fits FF evaporator in Samsung bottom freezers.

ELEMENT

MADE IN CHINA

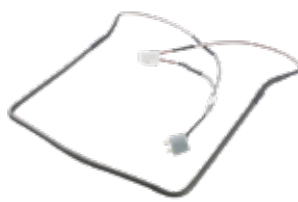
**DA47-00244QCM**

DEFROST HEATER
115V, 120W element with defrost thermostat.
Fits FF evaporator in Samsung bottom freezers.

ELEMENT

MADE IN CHINA

**DA47-00244UCM**

DEFROST HEATER
120V, 100W element with defrost thermostat.
Fits FF evaporator in Samsung bottom freezers.

ELEMENT

MADE IN CHINA

**DA47-00244WCM**

DEFROST HEATER
120V, 244 Watt stainless steel sheath. Fits Samsung bottom mount refrigerators.

ELEMENT

MADE IN CHINA

REFRIGERATOR

**DA47-00247HCM**

DEFROST HEATER
120V, 140W element with defrost thermostat.
Fits FF evaporator in Samsung SxS refrigerators.

ELEMENT

MADE IN CHINA

**DA47-00301DCM**

THERMAL FUSE
250V, 10A, thermo fuse.
Fits Samsung refrigerators.

ELEMENT

MADE IN CHINA

**DA47-00311ACM**

DEFROST HEATER
120V, 300W element with defrost thermostat.
Fits freezer evaporator in Samsung SxS refrigerators.

ELEMENT

MADE IN CHINA

**DA47-00322HCM**

DEFROST HEATER
115V, 140W element with defrost thermostat.
Fits FF evaporator in Samsung SxS refrigerators.

ELEMENT

MADE IN CHINA

REFRIGERATOR



DA47-00322JCM

DEFROST HEATER
120V, 140W element with defrost thermostat. Fits FF evaporator in Samsung SxS refrigerators.

ELEMENT MADE IN CHINA



DA47-00424LCM

DEFROST HEATER
115V, 120W element with defrost thermostat. Fits FF evaporator in Samsung bottom freezers.

ELEMENT MADE IN CHINA



DA47-00424MCM

DEFROST HEATER
120V, 240W element. Fits freezer evaporator in Samsung bottom freezers.

ELEMENT MADE IN CHINA



DA47-00434ACM

DEFROST HEATER
120V, 120W heater for refrigerator evaporator. Fits Samsung french door refrigerators.

ELEMENT MADE IN CHINA

REFRIGERATOR



DA61-04702ACM

CASTER
1 1/8" Diameter x 1 3/8" wide front caster. Fits Samsung SxS refrigerators.

TRIM MADE IN CHINA



DA61-04703ACM

CASTER (REAR)
1 1/2" Diameter x 1" wide rear caster. Fits Samsung SxS refrigerators.

TRIM MADE IN CHINA



DA61-14306ACM

DRAIN TUBE CLIP
Drain clip to extend defrost heater into drain. Fits Samsung refrigerators.

TRIM MADE IN CHINA

REFRIGERATOR



DA62-00914ACM

WATER VALVE
240V, 60Hz with compression inlet and quick connect outlets. Fits Samsung refrigerators.

WATER VALVE MADE IN CHINA



DA62-00914BCM

WATER VALVE
Dual coil with bracket. Fits Samsung french door refrigerators.

WATER VALVE MADE IN CHINA



DA62-00930ACM

WATER VALVE
Single coil with mounting bracket. Fits Samsung bottom freezer models.

WATER VALVE MADE IN CHINA

REFRIGERATOR

**DA62-01477ACM****WATER VALVE**

Single coil with compression inlet and quick disconnect outlet. Fits Samsung french door refrigerators.

WATER VALVE

MADE IN CHINA

**DA62-01477CCM****WATER VALVE**

Single coil with mounting bracket. Fits Samsung bottom freezer models.

WATER VALVE

MADE IN CHINA

**DA62-02360ACM****WATER VALVE**

240V, 60Hz with compression inlet and quick connect outlets. Fits Samsung refrigerators.

WATER VALVE

MADE IN CHINA

REFRIGERATOR

**DA62-02360BCM****WATER VALVE**

Dual coil with harness. Fits Samsung SxS refrigerators.

WATER VALVE

MADE IN CHINA

**DA63-02284BCM****ICE CUBE TRAY**

8 cube flex tray. Fits DA97-07603B Ice makers.

ICE MAKERS

MADE IN CHINA

**DA66-00649BCM****CASTER SHAFT**

Caster shaft for DA61-04702A and DA61-04703A casters. Fits Samsung SxS refrigerators.

TRIM

MADE IN CHINA

REFRIGERATOR

**DA81-01345BCM****FRENCH DOOR SPRING**

Door mullion spring.

MECHANICAL

MADE IN CHINA

**DA81-06013ACM****EVAPORATOR MOTOR**

12VDC, 0.16A axial evaporator fan motor. Fits Samsung bottom mount refrigerators.

MOTOR

MADE IN CHINA

**DA82-01396ACM****ICE BUCKET**

Long ice bucket assembly with DA97-14471A latch. Improved design with stainless steel auger. Also replaces DA97-14474C.

TRIM

MADE IN CHINA

SAMSUNG

REFRIGERATOR

**DA82-01397ACM****ICE BUCKET**

Short ice bucket assembly with DA97-14471A latch. Improved design with stainless steel auger. Also replaces DA97-14504C.

TRIM

MADE IN CHINA

**DA82-01415ACM****SERVICE KIT**

Water leak repair kit with updated internal duck bill. Fits Samsung refrigerators.

DRAIN HOSE

MADE IN CHINA

**DA82-02367ACM****CLIP ASSEMBLY**

Service kit to prevent defrost ice jam. Fits Samsung refrigerators.

MECHANICAL

MADE IN CHINA

REFRIGERATOR

**DA97-00258CCM****ICE MAKER**

Seven cube flex tray design. Fits Samsung SxS refrigerators.

ICE MAKERS

MADE IN CHINA

**DA97-02203GCM****ICE MAKER (WITHOUT HOUSING)**

Save over 40% buying the Ice Maker only, recycle existing mounting housing. Fits Samsung SxS refrigerators.

ICE MAKER

MADE IN CHINA

**DA97-04049DCM****DRAIN TUBE**

New style drain tube and cap assembly. Fits Samsung refrigerators.

MECHANICAL

MADE IN CHINA

REFRIGERATOR

**DA97-05368ACM****ICE CHUTE DOOR**

Fits DA97-13829C and DA97-08680G chute assemblies for Samsung french door refrigerators.

MECHANICAL

MADE IN CHINA

**DA97-05422ACM****ICE MAKER**

Seven cube flex tray design. Fits Samsung french door refrigerators.

ICE MAKERS

MADE IN CHINA

**DA97-07365GCM****ICE MAKER**

Nine cube ice mold, with 12 pin connector. Fits Samsung french door refrigerators.

ICE MAKERS

MADE IN CHINA

REFRIGERATOR



DA97-07549BCM

ICE MAKER

Seven cube ice mold with 12 pin connector. Fits Samsung and Kenmore SxS refrigerators.

ICE MAKERS

MADE IN CHINA



DA97-07592ACM

ICE MAKER

Seven cube ice mold with 12 pin connector. Fits Samsung bottom mount refrigerators.

ICE MAKERS

MADE IN CHINA



DA97-07603BCM

ICE MAKER

9 cube flex tray with 8 pin connector. Fits Samsung french door refrigerators.

ICE MAKERS

MADE IN CHINA

REFRIGERATOR



DA97-08059ACM

ICE MAKER

7 cube flex tray with 8 pin connector. Fits Samsung SxS refrigerators.

ICE MAKERS

MADE IN CHINA



DA97-08680GCM

ICE CHUTE

Includes dispenser motor, chute door and housing. Long harness fits Samsung standards depth and counter depth refrigerators.

MECHANICAL

MADE IN CHINA



DA97-12540GCM

AUGER MOTOR

Assembly includes cooling fan, auger motor, and fill tube heater. Fits Samsung SxS and french door refrigerators.

MOTOR

MADE IN CHINA

REFRIGERATOR



DA97-12540KCM

AUGER MOTOR

Assembly includes cooling fan, auger motor, and fill tube heater. Fits Samsung counter depth SxS and french door refrigerators.

MOTOR

MADE IN CHINA



DA97-12608ACM

EVAPORATOR COVER ASSEMBLY

FF evaporator cover assembly includes motor and thermistor. Fits Samsung bottom mount refrigerators.

MOTOR

MADE IN CHINA



DA97-12609CCM

EVAPORATOR COVER ASSEMBLY

FF evaporator cover assembly includes motor and thermistor. Fits Samsung french door refrigerators.

MOTOR

MADE IN CHINA

SAMSUNG

REFRIGERATOR

**DA97-12815BCM****EVAPORATOR FAN MOTOR**

DA81-06013A evaporator motor and housing assembly. Fits Samsung bottom mount refrigerators.

MOTOR

MADE IN CHINA

**DA97-13070ACM****DOOR CLOSER**

Auto closing lever with roller and heavy duty solid pin axle. Fits Samsung refrigerators.

TRIM

MADE IN CHINA

**DA97-13718CCM****ICE MAKER**

6 cube, solid tray with electronic eye sensor. Fits Samsung counter depth refrigerators.

ICE MAKERS

MADE IN CHINA

REFRIGERATOR

**DA97-13829CCM****ICE CHUTE**

120V, 60Hz, 3.5W step motor, chute and door assembly. Fits Samsung bottom freezer with ice and water in door.

MOTOR

MADE IN CHINA

**DA97-14471ACM****ICE BUCKET LOCK**

Lock and magnet for ice buckets. Fits Samsung refrigerators.

ICE MAKER

MADE IN CHINA

**DA97-15217DCM****ICE MAKER**

10 cube, solid tray with electronic eye sensor. Fits Samsung SxS and french door refrigerators.

ICE MAKER

MADE IN CHINA

**DA97-19898ACM****DRAIN TUBE AND HEATER****ASSEMBLY**

Mounts in auger motor assembly - includes improved insulation. Fits Samsung refrigerators.

ELEMENT

MADE IN CHINA

WASHER

**DC31-00054ACM****PUMP - WASHER**

120V, 60 Hz, 80W
Fits Samsung, Whirlpool and Kenmore washers.

PUMP

MADE IN CHINA

**DC31-00054DCM****WATER PUMP**

120V, 60Hz, 0.9A, 80W. Pump only for twist off housing. Fits Samsung front load washers.

PUMP

MADE IN CHINA

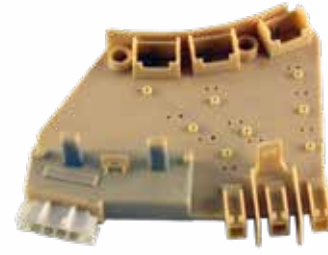
**DC31-00098ACM****MOTOR SENSOR**

Senses motor spin speed to determine out of balance load. Fits Samsung washers.

MECHANICAL

MADE IN CHINA

WASHER

**DC61-01257MCM****SPRING**

7 1/4" overall length. Suspension spring for tub.
Fits Samsung front load washers.

MECHANICAL

MADE IN UNITED STATES

**DC62-00142GCM****WATER VALVE**

3-way cold water valve.
Fits Samsung and Kenmore washers.

WATER VALVE

MADE IN CHINA

**DC62-00214LCM****WATER VALVE**

120V, 60Hz, four coil cold water valve. Fits Samsung front load washers with front control panel.

WATER VALVE

MADE IN CHINA

WASHER

**DC62-00214MCM****WATER VALVE**

120V, 60Hz, four coil valve.
Fits Samsung front load washers with top control panel.

WATER VALVE

MADE IN CHINA

**DC62-30312JCM****WATER VALVE**

2-way cold water valve.
Fits Samsung and Kenmore washers.

WATER VALVE

MADE IN CHINA

**DC62-30314KCM****WATER VALVE**

Hot water valve.
Fits Samsung and Kenmore washers.

WATER VALVE

MADE IN CHINA

WASHER

**DC64-00802ACM****TUB BOOT**

Replaces both DC64-00802A and DC64-00802B. Fits Samsung, Whirlpool and Kenmore washers.

GASKET

MADE IN CHINA

**DC64-01570ACM****TUB BOOT**

Rubber boot assembly.
Fits Samsung front-load washers.

GASKET

MADE IN CHINA

SAMSUNG

WASHER



DC66-00470ACM

DAMPER (FRONT)

Shock absorber mounts on front of tub. Fits Samsung front load washers.

MECHANICAL MADE IN CHINA



DC66-00470BCM

DAMPER (BACK)

Shock absorber mounts on rear of tub. Fits Samsung front load washers.

MECHANICAL MADE IN CHINA



DC66-00470CCM

DAMPER (FRONT)

Shock absorber mounts on front of tub. Fits Samsung washing machines.

MECHANICAL MADE IN CHINA



DC66-00531BCM

DAMPER (BACK)

Shock absorber mounts on rear of tub. Fits Samsung washing machines.

MECHANICAL MADE IN CHINA

WASHER



DC90-10128NCM

THERMISTOR

Thermistor regulates water temperature. Fits Samsung top load washers.

THERMISTOR MADE IN CHINA



DC96-00774ACM

WATER PUMP

Complete assembly with mounting bracket. Fits Samsung, Whirlpool and Kenmore washers.

PUMP MADE IN CHINA



DC96-01414ACM

WATER PUMP

120V, 60 Hz, 80W Includes mounting plate. Fits Samsung front load washers.

PUMP MADE IN CHINA

WASHER



DC96-01585LCM

WATER PUMP

120V, 60 Hz, 80W Fits Samsung front load washers.

PUMP MADE IN CHINA



DC96-01700ACM

WATER PUMP

120V, 60 Hz pump, coin trap and hose. Fits Samsung front load washers.

PUMP MADE IN CHINA



DC96-01703BCM

PRESSURE SWITCH

Direct replacement. Fits Samsung and Kenmore washers.

SWITCH MADE IN CHINA

WASHER



DC97-15459DCM

WATER VALVE

120V, 60Hz, hot and cold valve assembly. Fits Samsung top load washers.

WATER VALVE

MADE IN ITALY



DC97-15459GCM

WATER VALVE

120V, 60Hz, five coil linear valve. Fits Samsung top load washer.

WATER VALVE

MADE IN CHINA



DC97-15459HCM

WATER VALVE

120V, 60Hz, four coil linear valve. Fits Samsung top load washer.

WATER VALVE

MADE IN CHINA

WASHER



DC97-05280WCM

SUSPENSION ROD

26 1/4" long, sold individually (recommend replacing all four). Fits Samsung top load machines

MECHANICAL

MADE IN CHINA



DC97-16350CCM

SUSPENSION ROD

26" suspension spring/rod assembly. Fits Samsung top load washers.

MECHANICAL

MADE IN CHINA



DC97-16350DCM

DAMPER ASSEMBLY

27" suspension spring/rod assembly. Fits Samsung top load washers.

MECHANICAL

MADE IN CHINA



DC97-16350ECM

DAMPER ASSEMBLY

25 1/2" suspension spring/rod assembly. Fits Samsung top load washers.

MECHANICAL

MADE IN CHINA



QUALITY AND RELIABILITY BUILT IN

WHIRLPOOL

COOKING



12001656CM

OVEN SENSOR

Includes Sensor and two wire harness adapters. Fits Whirlpool ranges.

SENSOR

MADE IN CHINA



12001676CM

RANGE BLOCK (PORCELAIN)

HD Porcelain block and contacts. Fits Maytag and magic Chef ranges.

RECEPTACLE

MADE IN CHINA



12002121CM

INFINITE SWITCH

240V, 15A for dual surface element. With jumper. Fits Maytag glass top cooktop.

SWITCH

MADE IN MEXICO

COOKING



3148952CM

INFINITE SWITCH

240V, 5.4-7.8A switch for 6" elements. Fits Whirlpool electric ranges.

SWITCH

MADE IN MEXICO



3148953CM

INFINITE SWITCH

240V, 7.5-9.3A for 8" elements. Fits Whirlpool electric ranges.

SWITCH

MADE IN MEXICO



3149400CM

SWITCH INFINITE

8.9-11.0A, 240V. Fits Whirlpool 8" Elements.

SWITCH

MADE IN MEXICO



3149404CM

SWITCH INFINITE

5.2-6.6A, 240V. Fits Whirlpool 6" Elements.

SWITCH

MADE IN MEXICO

COOKING



330031CM

RANGE BLOCK (BAKELITE)

Includes folded mounting bracket, block, wire nuts and heat shrink. For Whirlpool ranges.

RECEPTACLE

MADE IN CHINA



330190CM

KNOB

Chrome skirt with black handle for vertical 8 shafts. Fits Whirlpool cooktops.

KNOB

MADE IN CHINA



4393799CM

12 3/4" TRAY

12" Diameter. Fits Whirlpool over-the-range microwave.

TRIM

MADE IN CHINA

COOKING

**4456027CM****INFINITE SWITCH**

120V, 15 Amp ceramic element.
Fits Kitchen-Aid cooktops.

SWITCH

MADE IN CROATIA

**74003122CM****INFINITE SWITCH**

15A, 240V dual infinite switch.
Fits Maytag glass top ranges.

SWITCH

MADE IN CROATIA

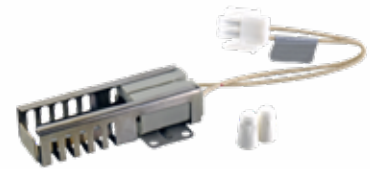
**74007498CM****RANGE IGNITER**

3.4 - 3.6 Amp, 3 3/4" bracket, 1 1/4" ceramic, 7" leads with male two pin block. Includes porcelain nuts.

IGNITER

MADE IN MEXICO

COOKING

**74008248CM****INFINITE SWITCH**

240V, 15A for dual surface element. Fits Jen-Air glass top cooktops.

SWITCH

MADE IN CROATIA

**74010824CM****INFINITE SWITCH**

240V, 15A for dual surface element. Fits Jen-Air glass top cooktops.

SWITCH

MADE IN CROATIA

**74011243CM****INFINITE SWITCH**

240V, 15A for dual ribbon element. For Maytag glass top cooktops and ranges.

SWITCH

MADE IN CROATIA

**74011489CM****INFINITE SWITCH**

120V, 15 Amp for plug in element package. Fits Jen-Aire downdraft models.

SWITCH

MADE IN CROATIA

COOKING

**7432P136-60CM****RANGE IGNITER**

3.4-3.6 Amp, 1 1/2" block, 3 3/4" cage w/90 degree bracket, 7 3/4" leads w/male spade. Replaces both bake or broil igniter.

IGNITER

MADE IN MEXICO

**7733P410-60CM****KNOB**

2" Diameter, 1/4" D shaft matte chrome finish surface knob. Fits Whirlpool cooktops.

KNOB

MADE IN CHINA

**8053334CM****GLIDE**

Rear drawer glide. Fits Whirlpool gas and electric ranges.

TRIM

MADE IN CHINA

WHIRLPOOL

COOKING



8203536CM

INFINITE SWITCH

240V, 15A for dual holgen burner. With jumper. Fits Kitchenaid free standing and slide in ranges.

SWITCH

MADE IN CROATIA



8273103CM

KNOB

Black surface burner knob with white indicator. Fits Whirlpool gas ranges.

KNOB

MADE IN CHINA



9755542CM

OVEN TEMP PROBE

4 1/2" meat probe with plug. Fits Whirlpool ovens.

ELECTRICAL

MADE IN CHINA

COOKING



9758060CM

INFINITE SWITCH

240V, 15A, switch. Fits Whirlpool glass top ranges.

SWITCH

MADE IN CROATIA



W10149355CM

INFINITE SWITCH

240V, 15A for dual surface element. Fits Maytag free standing ranges.

SWITCH

MADE IN CROATIA



W10181986CM

OVEN SENSOR

6" long probe, 1000 Ohm. Fits Whirlpool ranges.

SENSOR

MADE IN CHINA

COOKING



W10207928CM

MEMBRANE SWITCH (BLACK)

W10207930CM

MEMBRANE SWITCH (WHITE)

Twenty button membrane switch. Use with 8507P390-60 and W10177195 controllers.

TRIM

MADE IN UNITED STATES



W10331686CM

SPARK MODULE BOARD

Direct Spark ignition module. Fits Whirlpool gas ranges

ELECTRICAL

MADE IN CHINA



W10441696CM

INFINITE SWITCH

240V, 15A for dual surface element. Fits Whirlpool glass top ranges.

SWITCH

MADE IN CROATIA

COOKING



W10462778CM

INFINITE SWITCH
240V, 15A for large surface element. Fits Whirlpool glass top cooktops.

SWITCH

MADE IN CROATIA



W10807828CM

GLIDE (2 PACK)
Rear drawer glide. Fits Whirlpool gas and electric ranges.

TRIM

MADE IN CHINA



W10857622CM

INFINITE SWITCH
240V, 15A for large ceramic element. Fits Whirlpool ranges.

SWITCH

MADE IN MEXICO

COOKING



W10860916CM

SPARK MODULE BOARD
DSI Spark module. Fits Whirlpool ranges.

ELECTRICAL

MADE IN UNITED STATES



W10898291CM

SPARK MODULE BOARD
DSI Spark Module. Fits Whirlpool ranges.

ELECTRICAL

MADE IN UNITED STATES



W10918546CM

RANGE IGNITER
3.4 - 3.6 Amp, 1 1/2" block, 3 3/4" cage, 10" leads w/male pins. Bake igniter for single burner Whirlpool ranges.

IGNITER

MADE IN MEXICO

COOKING



W11162730CM

SPARK MODULE BOARD
DSI Spark module. Fits Whirlpool convection gas ranges.

ELECTRICAL

MADE IN UNITED STATES



WP3186491CM

RANGE IGNITER
3.4 - 3.6 Amp, 1 1/2" block, 3 3/4" cage, 10" leads w/male pins. Bake/Broil igniter for single burner Whirlpool ranges.

IGNITER

MADE IN MEXICO



WPW10511278CM

SPARK MODULE BOARD
Spark module for six burner gas ranges. Fits Whirlpool, Jen-Air, Maytag.

ELECTRICAL

MADE IN UNITED STATES

WHIRLPOOL

DISHWASHER



3400918CM

RETAINER

Retainer clip for top spray arm.
Fits Whirlpool dishwashers.

TRIM

MADE IN CHINA



34FHTCM

DISHWASHER 90° FITTING

90 Degree solid brass connector.
Single piece cast design.
Replacement for W10685193.

ADPATER

MADE IN CHINA



4317933CM

RACK ROLLER, SET OF 4

Lower rack rollers for W10311986.
Set of four.

TRIM

MADE IN CHINA

DISHWASHER



661658CM

WATER PUMP

120V, 60 Hz, 40W Drain Pump.
Pump only, connects to twist off housing.

PUMP

MADE IN CHINA



675813CM

THERMAL FUSE

Includes thermal fuse and wire harness. Fits Whirlpool built dishwashers.

MECHANICAL

MADE IN CHINA

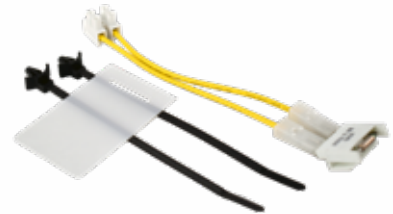

8193762CM

THERMAL CUTOUT

Thermal fuse and harness kit.
Includes TCO, harness, shield, zips and instructions.

ELECTRICAL

MADE IN CHINA

DISHWASHER



8194001CM

DOOR BALANCE LINK KIT

Includes complete set of roller assemblies and cable for both sides. Fits Whirlpool built deep tub dishwashers.

MECHANICAL

MADE IN CHINA



8269145CM

BRACKET

Mounting bracket for under-counter dishwashers.
Fits Whirlpool dishwashers.

TRIM

MADE IN CHINA



8270020CM

SPRING

Door balance spring - 7 3/4" overall length. Fits Whirlpool dishwashers.

MECHANICAL

MADE IN UNITED STATES

DISHWASHER

**8270182CM****SPRING**

6 5/8" overall length,
door balance spring.

MECHANICAL

MADE IN UNITED STATES

**8531669CM****WATER VALVE**

Direct replacement with
mounting bracket.
Fits Whirlpool built dishwashers.

WATER VALVE

MADE IN CHINA

**902894CM****DOOR GASKET**

66.5" L x .427" W x .445" H rubber
door seal.
Fits Maytag dishwashers.

GASKET

MADE IN CHINA

DISHWASHER

**913108CM****SHAFT SEAL**

Seal for solenoid shaft into the
pump housing. Fits Maytag
dishwashers.

MECHANICAL

MADE IN CHINA

**9743986CM****SPRING**

Door hinge spring - 7" overall
length. Fits Kitchenaid
dishwashers.

MECHANICAL

MADE IN UNITED STATES

**W10082861CM****RACK STOP**

Fits on rack rail to retain upper
rack. Fits Whirlpool dishwashers.

TRIM

MADE IN CHINA

DISHWASHER

**W10158291CM****DOOR BALANCE LINK KIT**

Link only from DW4001 kit.
Fits Whirlpool built deep tub
dishwashers.

MECHANICAL

MADE IN CHINA

**W10158389CM****WATER VALVE**

Direct replacement with
mounting bracket. Fits Whirlpool
dishwashers.

WATER VALVE

MADE IN CHINA

**W10195416CM****ROLLER ASSY**

Individual roller used in 4317933
kit. Fits Whirlpool dishwashers.

TRIM

MADE IN CHINA

WHIRLPOOL

DISHWASHER



W10195622CM

STOP

Track stop for upper rack. Fits Kitchenaid dishwashers.

TRIM

MADE IN CHINA



W10195839CM

RACK ADJUSTER

Strap tether adjuster for upper rack. Fits Whirlpool dishwashers.

TRIM

MADE IN CHINA



W10195840CM

RACK ADJUSTER

Upper rack adjuster positioner. Fits Whirlpool dishwashers.

TRIM

MADE IN CHINA

DISHWASHER



W10258275CM

THERMAL FUSE

86C, 187F Thermal fuse kit. Kit includes thermal fuse, wire harness and zip ties.

THERMOSTAT

MADE IN CHINA



W10327249CM

WATER VALVE

120V, 3/4" GHT inlet, 1/2" push on outlet. Fits Whirlpool dishwashers.

WATER VALVE

MADE IN CHINA



W10327250CM

WATER VALVE

120V, 3/4" GHT inlet, 1/2" push on outlet. Fits Whirlpool dishwashers.

WATER VALVE

MADE IN CHINA

DISHWASHER



W10348269CM

WATER PUMP

120V, 60 Hz, 0.7A, 45W. Drain pump for Whirlpool dishwashers.

PUMP

MADE IN CHINA



W10510667CM

WATER PUMP

120V, 60 Hz, 0.9A, 55W. Circulation pump for Whirlpool dishwashers.

PUMP

MADE IN CHINA



W10648041CM

WATER VALVE WITH CONNECTOR

120V, 3/4" GHT inlet, 1/2" push on outlet. W10327250 Valve and 34FHT adapter.

WATER VALVE

MADE IN CHINA

DISHWASHER

**W10705575CM****TURBIDITY SENSOR**

Senses water condition in dishwasher. Fits Whirlpool dishwashers.

ELECTRICAL

MADE IN ITALY

**W10712394CM****RACK ADJUSTER**

Upper Dishwasher rack roller rebuild kit. Includes metal attach and plastic parts.

MECHANICAL

MADE IN CHINA

**W10712395CM****RACK ADJUSTER**

Kit contains RH & LH adjuster assemblies and actuators. Fits Whirlpool dishwashers.

TRIM

MADE IN CHINA

DISHWASHER

**W10846093CM****WATER PUMP**

120V, 60 Hz, 1.2A, 60W main recirculation pump. Fits Whirlpool dishwashers.

PUMP

MADE IN CHINA

**W10876537CM****WATER PUMP**

120V, 60Hz, 0.7A 50W. Drain pump for Whirlpool dishwashers.

PUMP

MADE IN CHINA

**W11082871CM****WATER VALVE**

Compression inlet-barb outlet. Fits late model Maytag dishwashers.

WATER VALVE

MADE IN CHINA

DISHWASHER

**W11084656CM****WATER VALVE**

120V, 60Hz, 0.8A, motor and pump assembly. Fits Whirlpool dishwashers.

WATER VALVE

MADE IN CHINA

**W11412300CM****DISPENSER**

Detergent dispenser assembly. Fits Whirlpool and Kitchenaid dishwashers.

MECHANICAL

MADE IN MEXICO

**W11545764CM****FLOAT SWITCH**

Housing, switch and float assembly. Fits Whirlpool dishwashers.

SWITCH

MADE IN ITALY

WHIRLPOOL

DISHWASHER



WP8268743CM

ROLLER ASSEMBLY

Dark gray upper rack roller.
Fits Whirlpool dishwashers.

TRIM

MADE IN CHINA



WPW10082853CM

PIVOT TINE

Clip to lock down adjustable
tines on upper rack.
Fits Whirlpool dishwashers.

TRIM

MADE IN CHINA



WPW10212598CM

WATER VALVE

120V, 60Hz, single coil hot water
valve. Fits Whirlpool front load
dishwashers.

WATER VALVE

MADE IN CHINA

DRYER



12001541CM

DRUM SUPPORT ROLLER

Includes 303373 roller and two
312535 washers.
Fits Maytag dryers.

MECHANICAL

MADE IN CHINA



197CM

THERMOSTAT KIT

Includes L250-80F cycling
thermostat and L309F thermal
fuse. Fits Whirlpool dryers.

THERMOSTAT

MADE IN CHINA



21002026CM

SNUBBER

Mounts between base and
tripod. Fits commercial and
residential machines.

MECHANICAL

MADE IN CHINA

DRYER



279311CM

IGNITER - DRYER

3.4 - 3.6 Amps, 2" wide block.
Includes adapter brackets and
wire nuts to replace older spiral
igniters. Fits Whirlpool dryers.

IGNITER

MADE IN MEXICO



279347CM

LID SWITCH

Replaces both 279347 Lid Switch
and 279782 Belt Switch. Also
includes two brackets, terminals
and screws.

SWITCH

MADE IN CHINA



279393CM

NUT AND BOLT KIT

Replacement nuts and bolts for
terminal block. Chrome-plated
for added conductivity.

MECHANICAL

MADE IN CHINA

DRYER

**279640CM****PULLEY**

Idler pulley with self lubricating bearing. Fits large capacity Whirlpool built dryers with lint screen in front.

MECHANICAL

MADE IN CHINA

**279769CM****THERMAL CUTOFF KIT**

L250-80F high limit and 352F thermal fuse kit. Fits Whirlpool dryers.

THERMOSTAT

MADE IN CHINA

**279787CM****MOTOR**

Blower Shaft - 1 5/8", Drive Shaft - 1 1/4", 1/3 HP, 1725 RPM. Fits large capacity Whirlpool dryers with lint screen in front.

MOTOR

MADE IN CHINA

DRYER

**279816CM****THERMAL CUTOFF KIT 325F FUSE**

L250-80F high limit and 309F thermal fuse with jumper wire. Fits Whirlpool dryers.

THERMOSTAT

MADE IN CHINA

**279827CM****MOTOR**

Blower shaft - 1 3/4", Drive shaft - 1 3/4", 1/3 HP, 1725 RPM. Fits Whirlpool dryers with rear blower and lint filter on top.

MOTOR

MADE IN CHINA

**279973CM****THERMOSTAT KIT**

1 - 295F high limit (3391914), 1 - 352F thermal fuse (8318314). Fits Whirlpool dryers.

THERMOSTAT

MADE IN CHINA

DRYER

**280148CM****THERMOSTAT KIT**

L146-44C, 295-111F with 50 Ohm thermistor. Fits Whirlpool dryers.

THERMOSTAT

MADE IN CHINA

**303373KCM****DRUM ROLLER KIT, DRYER**

Kit includes shaft, washers and retainer. Fits Maytag dryers.

MECHANICAL

MADE IN CHINA

**306508CM****DRUM SLIDE PACKAGE**

Includes rivets and cushion. Fits Maytag dryers.

MECHANICAL

MADE IN CHINA

WHIRLPOOL

DRYER



33001003CM

LINT SCREEN

13" W x 10 1/4" T with rounded top.
Fits Maytag dryers built before 1990.

TRIM

MADE IN CHINA



33001808CM

LINT SCREEN

12 1/2" W x 7 3/4" T rectangular screen. Fits newer Maytag dryers.

TRIM

MADE IN CHINA



33002795CM

MOTOR, DRYER

120V/60 Hz, 1/4 HP. 1725 RPM.
Fits Commercial Maytag dryers.

MECHANICAL

MADE IN CHINA

DRYER



33002970CM

LINT SCREEN

13" W x 9" T with offset round top.
Fits Maytag dryers requiring magnet.

TRIM

MADE IN CHINA



3387223CM

ELECTRODE

Moisture sensing electrode.
Fits Whirlpool dryers.

ELECTRICAL

MADE IN CHINA



3390719CM

THERMAL FUSE

Single shot 190F/88C.
Fits Whirlpool and Kenmore dryers.

THERMAL CUTOFFS

MADE IN CHINA

DRYER



3392519CM

THERMAL FUSE

196F single blow fuse with 3/16" spade connectors.
Fits Whirlpool dryers.

THERMAL CUTOFFS

MADE IN CHINA

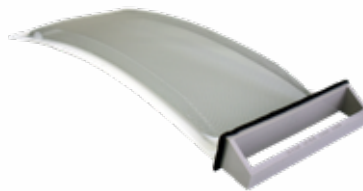

339392CM

LINT FILTER

18.75" Long, brown handle.
Fits Whirlpool dryers with top access.

TRIM

MADE IN CHINA



339956CM

FELT SEAL

28" dryer foam seal with adhesive backing.

MECHANICAL

MADE IN CHINA

DRYER

**3405281CM**

RELAY

240V, 30A, 48VDC coil.
Fits Whirlpool dryers.

SWITCH

MADE IN CHINA

**3406105CM**

LID SWITCH

SPDT 3-wire, with 7 1/2" harness.
Fits Whirlpool built dryers.

SWITCH

MADE IN CHINA

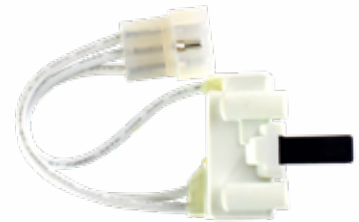
**3406107CM**

DOOR SWITCH

SPDT 3-wire, with 4" harness.
Fits Whirlpool built dryers.

SWITCH

MADE IN CHINA

DRYER

**3406108CM**

DOOR SWITCH

125-250V, 50/60Hz, 11A, 1/3HP,
w/ 12" harness. Fits Whirlpool
washer/dryer stack sets.

SWITCH

MADE IN CHINA

**349241CM**

DRUM SUPPORT ROLLER

Regular duty drum support roller.
Fits Whirlpool dryers.

MECHANICAL

MADE IN CHINA

**349241TCM**

DRUM ROLLER (2 PACK)

2-pack of the 349241.
Fits Whirlpool dryers.

MECHANICAL

MADE IN CHINA

DRYER

**349639CM**

LINT FILTER

21" long with black handle.
Fits Whirlpool dryers.

TRIM

MADE IN CHINA

**37001042CM**

ROLLER

Fits domestic and commercial
machines. Fits Amana and Speed
Queen dryers.

MECHANICAL

MADE IN CHINA

**37001142CM**

LINT SCREEN

Approximately 16 5/8" W x 7 1/2" T at
longest points, w/metal screen.
Fits Speed Queen, and Amana
dryers.

TRIM

MADE IN CHINA

WHIRLPOOL

DRYER



3977456CM

PTS SWITCH
120V, 2 terminal PTS switch.
Fits Whirlpool dryers.

SWITCH

MADE IN CHINA



3977767CM

THERMOSTAT LIMIT CONTROL
250F open, 170F close with
mounting bracket.
Fits Whirlpool dryers.

THERMOSTAT

MADE IN CHINA



4391996CM

IGNITER
3.4 - 3.6 Amps, 2" wide block,
same as 279311 w/o brackets.
Fits most Electrolux, GE and
Whirlpool dryers.

IGNITER

MADE IN MEXICO

DRYER



4392065CM

MAINTENANCE KIT
1x 341241CM - Dryer Belt
1x 691366CM - Idler Pulley
1x 349241TCM - Drum Roller (2)

MECHANICAL

MADE IN CHINA



4392067CM

MAINTENANCE KIT
1x 4011201CM - Dryer Belt
1x 279640CM - Pulley
4x W10314173CM - HD Rollers

MECHANICAL

MADE IN CHINA



49621CM

LEVELING LEG
Nylon threaded leg.
Fits Whirlpool & LG dryers.

MECHANICAL

MADE IN CHINA

DRYER



511629PCM

MOTOR
120V/60 Hz, 1/3 HP.
For commercial and residential.

MOTOR

MADE IN CHINA



53-0918CM

LINT SCREEN
15" W x 6" T, left guide 3/8", right 5/8".
Fits older Norge Harrin style
dryers.

TRIM

MADE IN CHINA



56461PCM

SHAFT (SPEED QUEEN)
Shaft only for idler arm.
For commercial and residential.

MECHANICAL

MADE IN CHINA

DRYER



6-3700340CM
BEARING IDLER ASSEMBLY
 2" diameter, pressed bearing.
 Fits Maytag dryers.

MECHANICAL

MADE IN CHINA



691366CM
IDLER ASSEMBLY
 Pulley and tension spring.
 Fits Whirlpool dryers with lint filter
 on top.

MECHANICAL

MADE IN CHINA



694089CM
DRYER BLOWER WHEEL
 8 5/8" diameter.
 Fits Whirlpool built dryers with
 rear blower and lint filter on top.

BLOWER

MADE IN CHINA

DRYER



8531964CM
LINT SCREEN
 11"T x 6 1/2"W basket filter.
 Fits Whirlpool compact dryers.

SCREENS

MADE IN CHINA



8547160CM
IDLER PULLEY
 Idler and bracket assembly.
 Fits 29" cabinet Cabrio dryers.

MECHANICAL

MADE IN CHINA



8547174CM
IDLER
 Idler pulley and bracket
 assembly. Fits Whirlpool dryers
 with lint screen on top.

MECHANICAL

MADE IN CHINA

DRYER



8557403CM
THERMAL CUTOUT
 L146-44C, 295-111F with 50 Ohm
 thermistor. Fits Whirlpool dryers.

THERMOSTAT

MADE IN CHINA



8557882CM
LINT FILTER
 23" White exterior exposed
 handle. Fits Whirlpool dryers.

TRIM

MADE IN CHINA



8557884CM
LINT FILTER
 120V/60Hz single coil valve with
 3/4" GHT inlet. Fits Electrolux top
 mount refrigerators and steam
 dryers.

TRIM

MADE IN CHINA

WHIRLPOOL

DRYER



8566493CM

RELAY
240V, 20A, 120V coil.
Fits Whirlpool washer/dryer
combo.

ELECTRICAL MADE IN UNITED STATES



8572270CM

LINT SCREEN
7" long handle, 24 1/2" overall
length. Fits Whirlpool dryers with
lint screen on top.

TRIM MADE IN CHINA



8577274CM

THERMISTOR
10K Ohms @ 70F.
Fits Whirlpool built dryers.

THERMISTOR MADE IN CHINA

DRYER



LA1053CM

THERMOSTAT KIT
Kit with 53-0771 High Limit, 53-
1096 Thermal fuse, plus 53-1182
thermal fuse. Fits both gas and
electric Maytag dryers.

THERMOSTAT MADE IN CHINA



W10111905CM

CATCH
Metal door catch, use with
W10295405 strike.
Fits large capacity Whirlpool built
dryers with lint screen in front.

MECHANICAL MADE IN CHINA



W10117655CM

PTS RELAY
120V, 50/60Hz, 110A, 1/2HP, AUX
SPST 1A 120V, 4-terminal.

SWITCH MADE IN CHINA

DRYER



W10118756CM

IDLER PULLEY ASSEMBLY
Idler and bracket assembly.
Fits large capacity Whirlpool built
dryers with lint screen in front.

MECHANICAL MADE IN CHINA



W10120998CM

LINT SCREEN
12 1/8"W x 10 5/8".
Fits large capacity Whirlpool built
dryers with lint screen in front.

TRIM MADE IN CHINA



W10295405CM

STRIKE
Metal latch and strike kit.
Fits 29" cabinet Cabrio dryers.

MECHANICAL MADE IN CHINA

DRYER

**W10314173CM**

HEAVY DUTY DRUM ROLLER
Fits Whirlpool dryers with lint screen inside door.

MECHANICAL

MADE IN CHINA

**W10328463CM**

COIL KIT
Primary and secondary coil molded together.
Fits Whirlpool dryers.

ELECTRICAL

MADE IN CHINA

**W10359269CM**

SHAFT
Right side drum roller shaft.
Fits Whirlpool dryers.

MECHANICAL

MADE IN CHINA

DRYER

**W10359270CM**

SHAFT
Left side drum roller shaft.
Fits Whirlpool dryers.

MECHANICAL

MADE IN CHINA

**W10420741CM**

PTS SWITCH
120V, 2 terminal PTS switch.
Fits Amana dryers.

SWITCH

MADE IN CHINA

**W10528947CM**

HUB
Hub and clip for drive basket.
Fits Whirlpool top load washers.

MECHANICAL

MADE IN CHINA

DRYER

**W10563095CM**

PTS RELAY (3 TERM)
120V, 50/60Hz, 10A, 1/2HP, 3 - terminal. Fits Whirlpool dryers.

SWITCH

MADE IN CHINA

**W10837240CM**

IDLER
Idler pulley and bracket assembly. Fits Whirlpool dryers with lint screen inside door.

MECHANICAL

MADE IN CHINA

**W10861225CM**

HANDLE
White door handle.
Fits Whirlpool dryers with lint screen on top

TRIM

MADE IN CHINA

WHIRLPOOL

DRYER



W1102592CM
LEVELING LEGS (4 PACK)
 4x plastic leveling leg.
 Fits Whirlpool dryers.

TRIM

MADE IN CHINA



W11353079CM
ELECTRONIC CONTROL
 Fits Kitchenaid dishwashers.

ELECTRICAL

MADE IN MEXICO



W11364931CM
MOTOR
 120V, 60Hz, 5.4 Amp, 1/3 HP.
 Fits Whirlpool dryers.

MOTOR

MADE IN CHINA

DRYER



WP31001556CM
IGNITER
 2.5 - 3.0 Amps, 1 1/4" block.
 Fits Admiral, Norge and Samsung dryers.

IGNITER

MADE IN MEXICO



WP3355458CM
LID SWITCH
 120V, 1/2 HP, 36" lead, 14" tube protector.
 Fits Whirlpool laundry centers.

SWITCH

MADE IN CHINA



WP37001298CM
DRUM GLIDE
 Teflon glide for front support.
 Fits late model Amana and Speed Queen dryers.

MECHANICAL

MADE IN CHINA



Y54414CM
IDLER PULLEY
 2 3/16" diameter x 1/4" wide.
 Fits Amana and Speed Queen dryers.

MECHANICAL

MADE IN CHINA

MICROWAVE



8183954CM
TURNTABLE MOTOR
 120V, 60Hz, 2.4W.
 Fits Whirlpool over range microwaves.

MOTOR

MADE IN CHINA



8190232CM
ALUMINUM/CARBON FILTER W/LENS
 11 1/2" x 11 3/4" x 3/8" carbon filter with lens. Fits Whirlpool range hoods.

FILTER

MADE IN MEXICO



8206232ACM
MICROWAVE PANEL RPL BULB 40W
 40W, 125V, medium base.
 Fits Whirlpool microwaves.

LIGHT BULB

MADE IN CHINA

MICROWAVE



W10207752CM

TURNTABLE RING

Turntable ring with rollers.

Fits older Whirlpool over counter microwaves.

TRIM

MADE IN CHINA



W10208631ACM

GREASE FILTER

5 7/8" x 13 3/8" x 3/21" aluminum filter. Fits Whirlpool over counter microwaves.

FILTER

MADE IN MEXICO

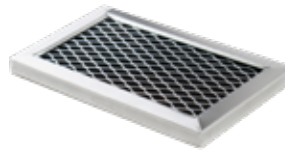

W10892387CM

CHARCOAL FILTER

3 1/4" x 5 1/4" x 3/8" carbon filter.

Fits Whirlpool over counter microwaves.

FILTER

MADE IN UNITED STATES



W11197783CM

WAVE GUIDE COVER

3" x 5 1/4" at longest point.

Fits Whirlpool over counter microwaves.

TRIM

MADE IN CHINA

REFRIGERATOR



1110702ACM

ICE MAKER

Using the existing harness, replaces hundreds of modular icemakers.

Fits Amana refrigerators.

ICE MAKERS

MADE IN CHINA



1129316CM

ICE MAKER

Includes icemaker, ice bin, water valve, fill line, tubes and harness.

Fits Whirlpool refrigerators.

ICE MAKERS

MADE IN CHINA



12002355CM

THERMISTOR

5/16" diameter with 31" leads.

Fits Amana, Maytag and Whirlpool bottom freezers.

THERMISTOR

MADE IN CHINA

REFRIGERATOR



12002744CM

EVAPORATOR FAN MOTOR

120V, 0.14A, 4.6W, 60Hz, 3000RPM.

Fits Maytag refrigerators.

MOTOR

MADE IN CHINA



12544002CM

WATER VALVE

120V, 50/60Hz, dual 20W and 35W coils. Fits Amana and Maytag SxS refrigerators.

WATER VALVE

MADE IN MEXICO

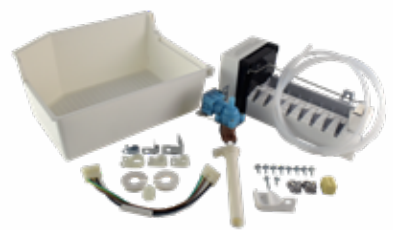

2155469ACM

ICE MAKER

Includes icemaker, ice bin, water valve, fill line, tubes and harness.

Fits Whirlpool refrigerators.

ICE MAKERS

MADE IN CHINA

WHIRLPOOL

REFRIGERATOR



2180353CM

ICE CHUTE DOOR

Fits Whirlpool SxS refrigerators.

TRIM

MADE IN CHINA



2187172CM

BIN

White removable door bin.
Fits Whirlpool SxS refrigerators.

TRIM

MADE IN CHINA



2188874CM

CONDENSER FAN MOTOR

120V, 4.1W, 60Hz.
Fits Whirlpool refrigerators.

MOTOR

MADE IN CHINA

REFRIGERATOR



2198597CM

ICE MAKER

Modular icemaker with heavy duty rake and extra wide stripper board.
Fits Whirlpool refrigerators.

ICE MAKERS

MADE IN CHINA



2315549CM

EVAPORATOR MOTOR

115V, 60Hz.
Fits Whirlpool SxS refrigerator.

MOTOR

MADE IN CHINA



2315576CM

WATER VALVE

120V, 35W quick connect outlets
 $\frac{3}{8}$ " compression inlet.
Fits Whirlpool french door refrigerators.

WATER VALVE

MADE IN CHINA

REFRIGERATOR



3-60336-001CM

EVAPORATOR FAN MOTOR

115V, 60Hz, 4.2W.
Fits Whirlpool upright freezers.

MOTOR

MADE IN CHINA



4317943CM

ICE MAKER

Includes icemaker and harness.
Fits Whirlpool refrigerators.

ICE MAKERS

MADE IN CHINA



4318046CM

WATER VALVE

Dual coil water valve.
Fits Whirlpool refrigerators.

WATER VALVE

MADE IN CHINA

REFRIGERATOR

**4318047CM****WATER VALVE**

Single coil water valve.
Fits Whirlpool refrigerators.

WATER VALVE

MADE IN CHINA

**4387489CM****DEFROST THERMOSTAT**

L70-58F, stripped ends, broad
metal tube mount.
Fits Whirlpool SxS refrigerators.

THERMOSTAT

MADE IN CHINA

**4387490CM****TUBE MOUNT THERMOSTAT**

5A @ 250V, 10A @ 120V, 48F open,
18F close, tube mount.

THERMOSTAT

MADE IN CHINA

REFRIGERATOR

**4387503CM****TUBE MOUNT THERMOSTAT**

5A @ 250V, 10A @ 120V, 44F open,
18F close, tube mount.

THERMOSTAT

MADE IN CHINA

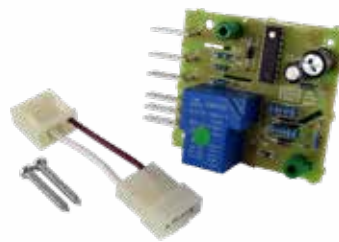
**4388931CM****DEFROST CONTROL**

Adaptive defrost control board.
Fits Whirlpool, Maytag, and
Kenmore refrigerators.

ELECTRICAL

MADE IN CHINA

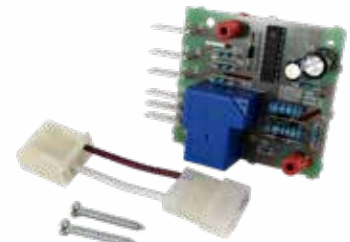
**4388932CM****DEFROST CONTROL**

Adaptive defrost control board.
Fits Whirlpool, Maytag, and
Kenmore refrigerators.

ELECTRICAL

MADE IN CHINA

REFRIGERATOR

**4389102CM****DEFROST CONTROL**

Ice level control board.
Fits Whirlpool, Maytag, and
Kenmore refrigerators.

ELECTRICAL

MADE IN CHINA

**4389147CM****EVAPORATOR FAN MOTOR**

120V, 60 Hz, 0.12A.
Fits older Whirlpool refrigerators.

MOTOR

MADE IN CHINA

**482731CM****EVAPORATOR FAN MOTOR**

120V, 0.26A, 60Hz, 3000RPM.
Kit includes blade, grommets and
bracket.

MOTOR

MADE IN CHINA

WHIRLPOOL

REFRIGERATOR



61004888CM
EVAPORATOR FAN MOTOR
 120V, 0.165A, 60Hz.
 Fits Maytag built refrigerators.

MOTOR MADE IN CHINA



61005273CM
WATER VALVE
 110V, single coil, quick connect outlet. Fits Whirlpool refrigerators.

WATER VALVE MADE IN CHINA



61005789CM
COLD CONTROL
 Discontinued by OEM.
 Fits Maytag top mount refrigerators.

THERMOSTAT MADE IN CHINA

REFRIGERATOR

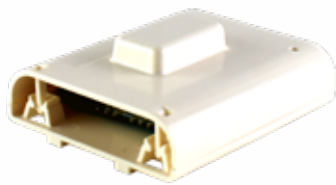

61005988CM
ADAPTIVE DEFROST BOARD
 120V, 6 pin, discontinued by OEM.
 Fits older Jen-Air and Maytag refrigerators.

DF CONTROL MADE IN CHINA



628366CM
ICE MAKER HEAD
 115V, 60Hz- Module Head.
 Fits Whirlpool built refrigerators.

ICE MAKERS MADE IN CHINA



67003753CM
WATER VALVE
 120V, 60Hz, 35W single coil.
 Fits Amana and Maytag bottom freezer refrigerators.

WATER VALVE MADE IN MEXICO

REFRIGERATOR



67005154CM
WATER VALVE
 120V, 1/4" inlet 1/4" and 5/16" outlet all push connect.
 Fits Whirlpool SxS refrigerators.

WATER VALVE MADE IN CHINA



67006322CM
WATER VALVE
 120V, 60Hz, 35W brown, 20W yellow coil.
 Fits Whirlpool, Maytag, Jen-Air french door refrigerators.

WATER VALVE MADE IN MEXICO



67006531CM
WATER VALVE
 110/120V, 50/60Hz, 35W brown, 20W yellow coil.
 Fits Whirlpool, Maytag, Jen-Air bottom freezer refrigerators.

WATER VALVE MADE IN MEXICO

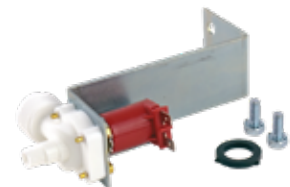

759296CM
WATER VALVE
 120V, 60Hz single coil.
 Fits Whirlpool ice machines. Replaces Horton IH3001.
 Discontinued by OEM.

WATER VALVE MADE IN CHINA

REFRIGERATOR

**8183202CM****HINGE**

8 1/4" base with dual fold bushings. Fits Whirlpool front load washers.

TRIM

MADE IN CHINA

**819470CM****COLD CONTROL**

250/125V, 50/60Hz, kit with instructions. Universal kit fits several Whirlpool refrigerators.

THERMOSTAT

MADE IN CHINA

**8201515CM****ICE MAKER MODULE**

115V, 60Hz-Module Kit with release rake. Fits Whirlpool refrigerators.

ICE MAKERS

MADE IN CHINA

REFRIGERATOR

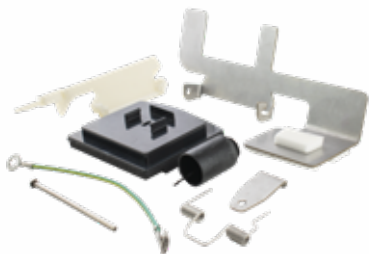
**8201756CM****DOOR CHUTE**

Door chute repair kit, used when door tabs are broken. Fits Whirlpool SxS refrigerators.

MECHANICAL

MADE IN CHINA

**8201786CM****COMPRESSOR START DEVICE KIT**

Includes two overloads, two start devices, a relay, and a cover. Fits Whirlpool refrigerators.

RELAY

MADE IN UNITED STATES

**D7712603CM****WATER VALVE**

120V, 60Hz, 20W coil. Fits older Amana, Admiral and Maytag refrigerators.

ICE MAKERS

MADE IN CHINA

REFRIGERATOR

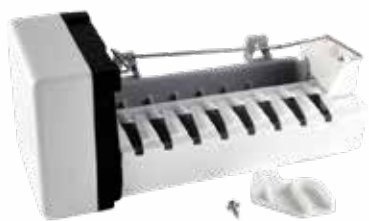
**D7824706QCM****ICE MAKER**

Using the existing harness, the RIM501 replaces hundreds of modular icemakers. Fits Amana refrigerators.

ICE MAKERS

MADE IN CHINA

**W10122496CM****ICE MAKER**

Includes icemaker, fill tubes and harness. Fits Whirlpool refrigerators.

ICE MAKERS

MADE IN CHINA

**W10122559CM****ICE MAKER**

Six cube heated mold tray. Fits Whirlpool french door refrigerators.

ICE MAKERS

MADE IN CHINA

WHIRLPOOL

REFRIGERATOR



W10124096CM

CONDENSER FAN MOTOR
120V, 0.17A, 60Hz.
Fits Whirlpool refrigerators.

MOTOR

MADE IN CHINA



W10128551CM

EVAPORATOR FAN MOTOR
115V, 60Hz, 0.14A.
Fits Whirlpool bottom freezer refrigerators.

MOTOR

MADE IN CHINA



W10179146CM

WATER VALVE
120V, dual 35W and 20W coils.
1/4" inlet, 1/4" and 5/16" outlets.

WATER VALVE

MADE IN CHINA

REFRIGERATOR



W10181323CM

CONDENSER MOTOR
115V, 60Hz, 4.1W, with 6 3/4" blade and mounting bracket.
Fits Whirlpool SxS refrigerators.

MOTOR - DC

MADE IN CHINA



W10188389CM

EVAPORATOR FAN MOTOR
120V, 60Hz, 0.12A, 2950RPM.
Fits Whirlpool 14, 16 and 18CF top mount refrigerators.

MOTOR

MADE IN CHINA



W10189703CM

EVAPORATOR FAN MOTOR
120V, 0.135A, 60Hz, 3000RPM.
Fits Whirlpool refrigerators.

MOTOR

MADE IN CHINA

REFRIGERATOR



W10190961CM

ICE MAKER
5 cube modular icemaker is designed to replace Whirlpool, Kenmore, and Maytag.
Fits Whirlpool refrigerators.

ICE MAKERS

MADE IN CHINA



W10190965CM

ICE MAKER
Eight cube heated mold with flat 4 pin plug. Ice maker only. Use hardware from old ice maker.
Fits Whirlpool SxS refrigerators.

ICE MAKERS

MADE IN CHINA



W10190981CM

ICE MAKER
Base ice maker.
Fits Whirlpool french door refrigerators.

ICE MAKER

MADE IN CHINA

REFRIGERATOR

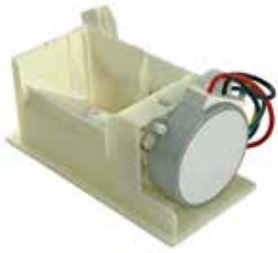
**W10196393CM****DAMPER CONTROL**

120V, 60Hz, 3.5W synchronous motor and housing assembly. Fits Whirlpool bottom freezer refrigerators.

MECHANICAL

MADE IN CHINA

**W10238100CM****WATER VALVE**

120V, 60Hz, 20W solenoid. Fits Whirlpool bottom mount refrigerators.

WATER VALVE

MADE IN CHINA

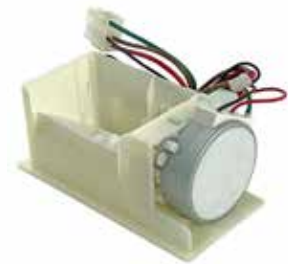
**W10248595CM****DAMPER CONTROL**

120V, 60Hz, 3.5W synchronous motor and housing assembly. Fits Whirlpool bottom freezer refrigerators.

MECHANICAL

MADE IN CHINA

REFRIGERATOR

**W10257451CM****DAMPER CONTROL**

120V, 60Hz, 4W damper motor and housing assembly. Fits Whirlpool french door refrigerators.

MECHANICAL

MADE IN CHINA

**W10258562CM****WATER VALVE**

110/120V, 50/60Hz, dual 20W and 35W coils. Fits Whirlpool SxS refrigerators.

WATER VALVE

MADE IN MEXICO

**W10271506CM****AUGER MOTOR**

115V, 0.6A, 11.3N Torque, 15±15% RPM. Fits Whirlpool french door and SxS refrigerators.

MOTOR

MADE IN CHINA

**W10279866CM****WATER VALVE**

110/120V, 50/60Hz, dual 20W and 35W coils. Fits Whirlpool french door refrigerators.

WATER VALVE

MADE IN MEXICO

REFRIGERATOR

**W10300022CM****ICE MAKER**

Replacement ice maker utilizes components from original. Fits Whirlpool SxS refrigerators.

ICE MAKERS

MADE IN CHINA

**W10300024CM****ICE MAKER**

Ice Maker only used in W10882923 kit. Fits Whirlpool SxS refrigerators.

ICE MAKERS

MADE IN CHINA

**W10312696CM****WATER VALVE**

110/120V, 50/60Hz, 35W brown and 20W green coils. Fits over 300 Whirlpool french door refrigerators.

WATER VALVE

MADE IN CHINA

WHIRLPOOL

REFRIGERATOR



W10341320CM

WATER VALVE

110/120V, 50/60Hz, 20W and 35W coils. Fits Whirlpool SxS refrigerators with in door ice system.

WATER VALVE

MADE IN CHINA



W10341329CM

WATER VALVE

110/120V, 50/60Hz, 20W and 35W coils. Fits Whirlpool bottom refrigerators with freezer on bottom.

WATER VALVE

MADE IN CHINA



W10366605CM

DEFROST CONTROL BOARD

Electronic control board for the defrost cycle. Fits Whirlpool refrigerators.

ELECTRICAL

MADE IN CHINA

REFRIGERATOR



W10383615CM

THERMISTOR

1" Bulb with 4 3/4" lead with quick disconnect plug. Fits top mount Whirlpool refrigerators.

THERMISTOR

MADE IN CHINA



W10384183CM

THERMISTOR

1" probe, 3 1/2" lead thermistor for refrigerator compartment. Fits Whirlpool french door refrigerators.

THERMISTOR

MADE IN CHINA



W10408179CM

WATER VALVE

120V, 1/4" inlet 1/4" and 5/16" outlet all push connect. Fits Whirlpool SxS refrigerators.

WATER VALVE

MADE IN CHINA

REFRIGERATOR



W10420083CM

WATER VALVE

110/120V 50/60Hz, Coil 1-20W, Coil 2-35W. Fits Whirlpool french door refrigerators.

WATER VALVE

MADE IN CHINA



W10479155CM

DAMPER

120V, 60Hz, 3.5W motor, and damper assembly. Fits Whirlpool french door refrigerators.

DAMPER

MADE IN CHINA



W10498976CM

WATER VALVE

110/120V, 50/60Hz, 35W coil. Fits Whirlpool refrigerators with freezer on bottom.

WATER VALVE

MADE IN CHINA

REFRIGERATOR

**W10515057CM****LED MODULE**

LED light module with white bezel, tapered lens and two male pin connector on board. Fits Whirlpool SxS refrigerators.

ELECTRICAL

MADE IN CHINA

**W10515058CM****LED MODULE**

LED light module with white bezel, flat lens and large two pin male inlet and small two male outlet pin connector on board.

ELECTRICAL

MADE IN CHINA

**W10594329CM****DAMPER CONTROL**

120V, 60Hz, 3 1/2"W motor and damper assembly. Fits Whirlpool french door refrigerators.

DAMPER

MADE IN CHINA

**W10594330CM****DAMPER CONTROL**

120V, 60Hz, 3 1/2"W motor and damper assembly. Fits Whirlpool bottom mount refrigerators.

DAMPER

MADE IN CHINA

REFRIGERATOR

**W10667607CM****THERMISTOR**

1" probe, 21 3/4" lead thermistor for refrigerator compartment. Fits Whirlpool bottom mount built in refrigerators.

THERMISTOR

MADE IN CHINA

**W10695459CM****LED MODULE**

LED light module with white bezel and small female pin connectors in white terminal block.

ELECTRICAL

MADE IN CHINA

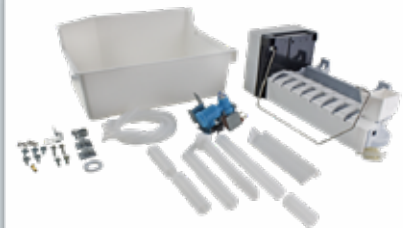
**W10715708CM****ICE MAKER KIT**

Complete kit for add on ice maker installations. Fits Whirlpool refrigerators from 1993 to current. Replaces ECKMF95 and IMKIT94.

ICE MAKERS

MADE IN CHINA

REFRIGERATOR

**W10715709CM****ICE MAKER**

Install kit for refrigerators with water valve and wire harness already installed. Fits Whirlpool top mount refrigerators.

ICE MAKERS

MADE IN CHINA

**W10814173CM****DAMPER CONTROL**

120V, 60Hz, 3.5W motor and damper assembly with styrofoam channel. Fits Whirlpool SxS refrigerators.

DAMPER

MADE IN CHINA

**W10822278CM****DEFROST TIMER**

120V, 50/60Hz, 8 Hour, 21 Minute. With flying lead and mounting screws.

ELECTRICAL

MADE IN CHINA

WHIRLPOOL

REFRIGERATOR

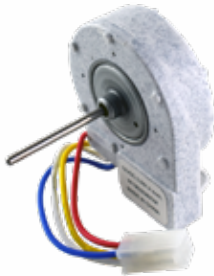

W10822580CM

EVAPORATOR FAN MOTOR
12VDC, 3.0W, 4 pin connector.
Fits Whirlpool SxS refrigerators.

MOTOR

MADE IN CHINA



W10823377CM

ICE DOOR KIT
Ice chute door kit includes ice door, support and spring.
Fits Whirlpool SxS refrigerators.

MECHANICAL

MADE IN CHINA



W10838965CM

THERMISTOR
1" probe, 9 3/4" lead thermistor for refrigerator compartment.
Fits Whirlpool top mount refrigerators.

THERMISTOR

MADE IN CHINA

REFRIGERATOR



W10846539CM

BLOWER MOTOR
14VDC, 0.38A, brushless motor for ice room. Fits Whirlpool french door refrigerators.

MOTOR

MADE IN CHINA



W10854032CM

LED MODULE
LED light module with white bezel and small male pin connectors.
Fits Whirlpool french door refrigerators.

ELECTRICAL

MADE IN CHINA



W10873791CM

ICE MAKER
10 Cube flex tray ice maker.
Fits Whirlpool SxS refrigerators with ice maker in the door.

ICE MAKERS

MADE IN CHINA

REFRIGERATOR

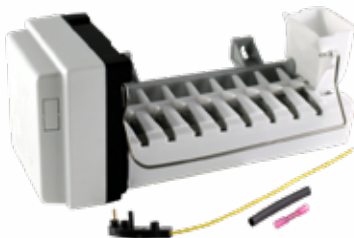

W10882923CM

ICE MAKER
Easy installation utilizes short adapter harness instead of re-wiring freezer.
Fits Whirlpool SxS refrigerators.

ICE MAKERS

MADE IN CHINA



W10884390CM

ICE MAKER
Includes harness, air diffuser and bail arm. Fits Amana and Whirlpool bottom mount refrigerators.

ICE MAKERS

MADE IN CHINA



W10898951CM

ICE BUCKET
Lock and magnet for ice buckets.
Fits Samsung refrigerators.

ICE MAKERS

MADE IN CHINA

REFRIGERATOR

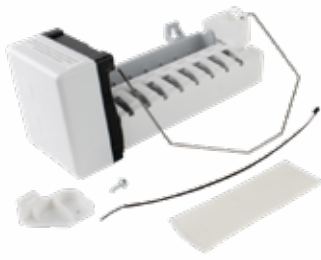
**W10916040CM****ICE MAKER**

Eight cube heated mold tray with stainless heater guard.
Fits Whirlpool SxS refrigerators.

ICE MAKERS

MADE IN CHINA

**W11043013CM****WATER VALVE**

120V, 20W, 35W two coil, quick connect inlet and outlet.
Fits Whirlpool french door refrigerators.

WATER VALVE

MADE IN MEXICO

**W11087463CM****DAMPER CONTROL**

120V, 60Hz, 4W damper motor and housing assembly.
Fits Whirlpool french door refrigerators.

MECHANICAL

MADE IN CHINA

REFRIGERATOR

**W11127829CM****CONDENSER MOTOR**

115V, 60Hz, 6W condenser fan motor. Fits Whirlpool french door refrigerators.

MOTOR

MADE IN CHINA

**W11130208CM****LED MODULE**

LED light module with white bezel and small female pin connectors in black terminal block.

ELECTRICAL

MADE IN CHINA

**W11164593CM****DAMPER CONTROL**

120V, 60Hz, 3.5W motor and damper assembly with styrofoam housing. Fits Whirlpool SxS refrigerators.

DAMPER

MADE IN CHINA

REFRIGERATOR

**W11104452CM****LED MODULE**

LED light module with white bezel, flat lens and two male pin connector on board.
Fits Whirlpool SxS refrigerators.

ELECTRICAL

MADE IN CHINA

**W11117909CM****AUGER MOTOR**

115V, 0.6A, 11.3N Torque, 15±15% RPM. Fits Whirlpool french door refrigerators.
Also replaces W11430832

MOTOR

MADE IN CHINA

**W11174006CM****LED MODULE**

LED light module with gray bezel and small female pin connectors.
Fits Whirlpool french door refrigerators.

ICE MAKER

MADE IN CHINA

WHIRLPOOL

REFRIGERATOR



W11205082CM

**LED LIGHT HARNESS
(CHROME)**

3 LED light moduals wired in series. Chrome Bezel. Fits Whirlpool french door refrigerators.

ELECTRICAL MADE IN CHINA



W11226500CM

LED BOARD

LED light module with white bezel, flat lens. Two pin male, three pin male and small two male outlet pin connector on board.

ELECTRICAL MADE IN CHINA



W11239944CM

**LED LIGHT HARNESS
(WHITE)**

3 LED light moduals wired in series. White Bezel. Fits Whirlpool french door refrigerators.

ELECTRICAL MADE IN CHINA



W11462342CM

LED MODULE

LED light module with chrome bezel and small female pin connectors in white terminal block.

ELECTRICAL MADE IN CHINA

REFRIGERATOR



W11577195CM

ICE MAKER

120V, 60Hz, ceiling mounted ice maker with 2 pin harness in head. Fits Whirlpool french door refrigerators.

ICE MAKER MADE IN CHINA



W11579560CM

ICE MAKER

120V, 60Hz, ceiling mounted ice maker with 2 pin connector in harness. Fits Whirlpool french door refrigerators.

ICE MAKER MADE IN CHINA



WP12729128CM

DEFROST HEATER

115V, 135W heater with rubber grommets. Fits Whirlpool bottom mount refrigerators.

DF HEATER MADE IN CHINA

REFRIGERATOR



WP2217220CM

CIRCULATION PUMP

Assembly included motor, pump and metal plate. Fits Whirlpool ice machines.

ICE MAKERS MADE IN CHINA



WP2315539CM

EVAPORATOR MOTOR

120V, 60 Hz, 2 pin block. Fits Whirlpool top mount refrigerators.

MOTOR MADE IN CHINA



WPW10251076CM

ICE MAKER

6 Cube ice mold with 5 pin harness. Fits Whirlpool SxS refrigerators with in door ice system.

ICE MAKERS MADE IN CHINA

SMALL APPLIANCE



9704230CM

BLENDER COUPLER

Coupler drives the dome and blade assembly. Fits KitchenAid mixers.

TRIM

MADE IN CHINA



W10490648CM

BEATERS (PAIR)

Left and right beater set. Fits KitchenAid hand mixers.

TRIM

MADE IN CHINA



W10672617CM

BEATER (K45B)

Flat beater with chip resistant powder coated Teflon. Fits Kitchenaid K45B mixers.

TRIM

MADE IN CHINA

SMALL APPLIANCE



W10674618CM

DOUGH HOOK (K45DH)

Dough hook with improved powder coating. Replaces K45DH for Kitchenaid mixers.

TRIM

MADE IN CHINA



W10674621CM

DOUGH HOOK (K5ADH)

Dough hook with improved powder coating. Replaces K5ADH for Kitchenaid mixers.

TRIM

MADE IN CHINA



W10731415CM

WIRE WHIP (K5AWW)

Recommended for mixtures that require air. Replaces K5AWW for Kitchenaid mixers.

TRIM

MADE IN CHINA

SMALL APPLIANCE



W10807813CM

BEATER (K5AB)

Flat beater with chip resistant powder coated Teflon. Fits Kitchenaid K5AB mixers.

TRIM

MADE IN CHINA



W11050447CM

OVERLAY - TRASH COMPACTOR

3 Button black overlay. Fits Whirlpool trash compactors.

TRIM

MADE IN UNITED STATES

TRASH COMPACTOR



4151750CM

AIR FILTER

4 1/4" x 4.3/4" x 1/2" carbon pad. Fits Whirlpool trash compactors.

FILTER

MADE IN UNITED STATES

WHIRLPOOL

WASHER



201566PCM

WATER PUMP

Direct Drive.

For commercial and residential.

PUMP

MADE IN CHINA



25001052CM

WATER PUMP

120V, 60 Hz, 80W.

Fits Maytag Neptune front load washers.

PUMP

MADE IN CHINA



280187CM

WATER PUMP

120V, 60 Hz, 0.70W.

Fits Whirlpool Duet/H3 front load washers.

PUMP

MADE IN CHINA

WASHER



285671CM

LID SWITCH

24" Harness with round plugs, 7/8" block. Fits Whirlpool direct drive washers.

SWITCH

MADE IN CHINA



285744CM

PAD

3 - pack shoes for skate plate. Fits Whirlpool direct drive washers.

MECHANICAL

MADE IN CHINA



285753ACM

MOTOR DRIVE COUPLER

Standard duty with metal insert to prevent stripping. Fits direct drive Whirlpool washers.

MECHANICAL

MADE IN CHINA

WASHER



285753CM

DRIVE COUPLER, MOTOR

Standard duty without metal insert. Fits direct drive Whirlpool washers.

MECHANICAL

MADE IN CHINA



285785CM

CLUTCH KIT

Includes 285790 lining and springs for 24" and 27" machines. Fits Whirlpool direct drive washers.

MECHANICAL

MADE IN CHINA



285790CM

LINER KIT

Lining kit used in 285785 clutch. Fits Whirlpool direct drive washers.

MECHANICAL

MADE IN CHINA

WASHER



285811CM

AGITATOR CAM KIT

2 1/4" tall cam, includes dogs spacer and gaskets.
Fits Whirlpool direct drive washers with dual agitation.

MECHANICAL

MADE IN CHINA



285852ACM

MOTOR COUPLING (HEAVY DUTY)

Heavy duty, extra reinforced rubber. Fits direct drive Whirlpool washers.

MECHANICAL

MADE IN CHINA



3355806CM

LID SWITCH

11" harness with round plugs, 7/8" block. Fits Whirlpool stack set.

SWITCH

MADE IN CHINA

WASHER



3363394CM

WATER PUMP

Standard 1 1/4" outlet.
Fits Whirlpool direct drive washers.

PUMP

MADE IN CHINA



3363892CM

WATER PUMP

Oversized 1 3/4" outlet with flapper.
Fits Whirlpool direct drive washers.

PUMP

MADE IN CHINA



35-6465CM

WATER PUMP

Pump assembly with metal plate and pulley. Fits Norge washers.

PUMP

MADE IN CHINA

WASHER



35-6780CM

WATER PUMP

Plastic pump assembly and pulley. Fits Norge washers.

PUMP

MADE IN CHINA



358684CM

ACTUATOR

Fits machines with paddle operated switch. Fits Whirlpool direct drive washers.

MECHANICAL

MADE IN CHINA



38034CM

MOTOR

120V/60 Hz, 1/2 HP, 2 SP.
Fits Speed Queen commercial and domestic machines.

MOTOR

MADE IN CHINA

WHIRLPOOL

WASHER



389140CM

DRIVE BLOCK

Cast metal drive hub.
Fits Whirlpool direct drive washers.

MECHANICAL

MADE IN CHINA



389248CM

MOTOR - WASHER

½ HP, 1725/1140 RPM.
Fits Whirlpool direct drive washers.

MOTOR

MADE IN CHINA



3949238CM

LID SWITCH

19" harness with 8" protective tube and metal deflector. Fits Whirlpool direct drive washers.

SWITCH

MADE IN CHINA

WASHER



3949247CM

LID SWITCH

27" Harness with 14" protective tube. 1 ½" terminal block. Fits Whirlpool direct drive washers.

SWITCH

MADE IN CHINA



80040CM

285770 AGITATOR DOGS (4 PC)

Four piece agitate dogs. Fits Whirlpool direct drive washers with dual agitation.

MECHANICAL

MADE IN CHINA



8181694CM

WATER VALVE

Two solenoid valve with 50 ohm thermistor. Fits Whirlpool front load machines.

WATER VALVE

MADE IN CHINA

WASHER



8181846CM

HANDLE

Light gray.
Fits Whirlpool built front load washers.

KNOB

MADE IN CHINA



8182119CM

DOOR BOOT

16" Diameter door boot seal.
Fits Whirlpool front load washers.

GASKET

MADE IN CHINA



8182703CM

SHOCK ABSORBER

9" long x 1" diameter.
Fits Whirlpool front load washers.

MECHANICAL

MADE IN CHINA

WASHER

**8182862CM****WATER VALVE**

Two solenoid valve with 50 ohm thermistor. Fits Whirlpool front load washers.

WATER VALVE

MADE IN CHINA

**8318084CM****LID SWITCH**

Mounts into top. Fits Whirlpool direct drive washers.

SWITCH

MADE IN CHINA

**8540221CM****STRIKE**

Door hook. Fits Whirlpool front load washers.

TRIM

MADE IN CHINA

WASHER

**8540751CM****WATER VALVE**

120V, 5W coils, 1/2" outlet. Fits Whirlpool front load washers.

WATER VALVE

MADE IN CHINA

**91938CM****SPIN TUBE SEAL**

Steel insert, rubber covered for spin tube. Fits Whirlpool belt drive washers.

MECHANICAL

MADE IN CHINA

**91939CM****SHAFT SEAL**

Steel insert, rubber covered, seals agitate shaft to spin tube. Fits Whirlpool belt drive & direct drive washers.

MECHANICAL

MADE IN CHINA

WASHER

**12002351CM****MOTOR - WASHER**

1 - Speed, 1/2 HP, 120V, 60 Hz, 1725 RPM. Fits Maytag commercial and domestic washers.

MOTOR

MADE IN CHINA

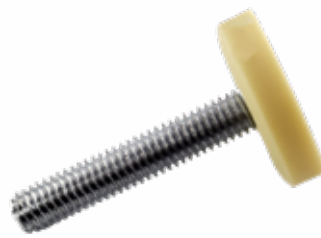
**W1000130CM****LEG**

Threaded leveling leg with 1 1/2" urethane protected foot pad. Fits Whirlpool washers.

MECHANICAL

MADE IN CHINA

**W10130913CM****WATER PUMP**

Complete pump motor assembly. Fits Whirlpool front load washers.

PUMP

MADE IN CHINA

WHIRLPOOL

WASHER



W10140917CM

WATER VALVE

120V, dual valve with siphon break and thermostat. Fits Whirlpool top load direct drive washers.

WATER VALVE

MADE IN CHINA



W10144820CM

WATER VALVE

Complete inlet valve and vacuum break assembly with square connector block. Fits Whirlpool top load washers.

WATER VALVE

MADE IN CHINA



W10178988CM

MOTOR POSITION SENSOR

Senses motor spin speed to determine out of balance load. Fits Whirlpool top load washer, mounts on direct drive motor.

MECHANICAL

MADE IN CHINA

WASHER

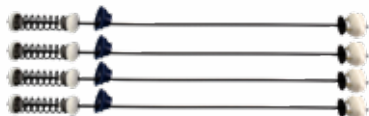

W10189077CM

SUSPENSION KIT

Kit includes four sets of rods and dampers. Fits Whirlpool VM washers.

MECHANICAL

MADE IN CHINA



W10208415CM

HINGE

9 13/16" long door hinge base. Fits Whirlpool front load washers.

MECHANICAL

MADE IN CHINA



W10250667CM

SPRING

Suspension counter spring 6 1/2" long. Fits Whirlpool direct drive washers.

MECHANICAL

MADE IN CHINA

WASHER



W10276397CM

WATER PUMP

120V, 60 Hz, 0.95A. Fits Whirlpool top load washers.

PUMP

MADE IN CHINA



W10247306CM

WATER VALVE

120V, 50/60Hz, three coil valve. Fits Whirlpool front load washers with top control panel.

WATER VALVE

MADE IN CHINA



W10289387CM

WATER VALVE

120V, 50/60Hz, two coil valve with pin connectors & 90 degree outlet. Fits Whirlpool front load washers.

WATER VALVE

MADE IN CHINA

WASHER

**W10391443CM****WATER PUMP**

120V, 60 Hz, 0.95A pump and coin trap. Fits Whirlpool front load washers.

PUMP

MADE IN CHINA

**W10404050CM****LID SWITCH**

120V, 10Amp, 1/3 HP lock circuit. Fits Whirlpool top load washers.

SWITCH

MADE IN CHINA

**W10409079CM****WATER PUMP**

120V, 60 Hz, 1.20A, 70W. Fits Whirlpool top load washers.

PUMP

MADE IN CHINA

WASHER

**W10440729CM****SUSPENSION CUPS**

Contains four cups and four balls for suspension rods. Fits Whirlpool top load washers.

MECHANICAL

MADE IN CHINA

**W10440786CM****SUSPENSION KIT**

Fits Whirlpool Cabrio and Maytag Bravos washers. 27 5/8" rods, set of four.

MECHANICAL

MADE IN CHINA

**W10465252CM****WATER PUMP**

120V, 60 Hz, 0.6A, 24W. Fits Whirlpool compact front load washers.

PUMP

MADE IN CHINA

WASHER

**W10514214CM****PRESSURE SWITCH**

120V six spade connector pressure switch. Fits Whirlpool front load washer.

SWITCH

MADE IN CHINA

**W10536347CM****PUMP - WASHER**

120V, 60 Hz, 0.95 W. Fits Whirlpool Cabrio style top load washers.

PUMP

MADE IN CHINA

**W10581874CM****WATER PUMP**

120V, 60hz, 1.25A pump motor and housing. Fits Whirlpool top load washers.

PUMP

MADE IN CHINA

WHIRLPOOL

WASHER



W10599356CM

WATER VALVE

120V, 60Hz, three coil valve with extension hoses. Fits Whirlpool front load washers.

WATER VALVE

MADE IN CHINA



W10605427CM

WATER PUMP

120V, 60Hz, 0.95A drain pump and housing assembly. Fits Whirlpool front load machines.

PUMP

MADE IN CHINA



W10661045CM

WATER PUMP

120V, 60Hz, 1.2A drain pump and housing. Fits Whirlpool top load machines.

PUMP

MADE IN CHINA

WASHER

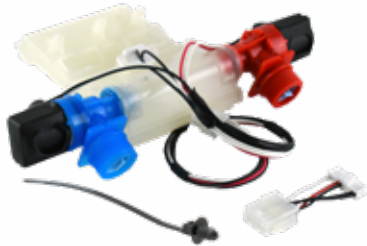

W10683603CM

WATER VALVE

Complete inlet valve and vacuum break assembly with flat pin connector block. Fits Whirlpool top load washers.

WATER VALVE

MADE IN CHINA



W10721967CM

CLUTCH KIT

Includes spring, housing, cam ring, basket drive gear, pulley, and nut. Fits VM Washing Machines

MECHANICAL

MADE IN CHINA



W10730972CM

WATER PUMP

120V, 60Hz, 1.25A, pump motor with coin trap. Fits Whirlpool front load washers.

PUMP

MADE IN CHINA

WASHER



W10754448CM

CLUTCH

120V, 60Hz, electro magnetic clutch assembly. Fits Whirlpool large capacity top load washers.

MECHANICAL

MADE IN CHINA

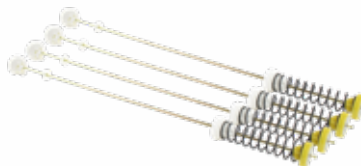

W10780045CM

SUSPENSION ROD SET

24" long rod assembly, set of four. Fits Whirlpool top load machines.

MECHANICAL

MADE IN CHINA



W10780048CM

SUSPENSION KIT

24" long rod assembly, set of four. Fits Whirlpool VMW washers.

MECHANICAL

MADE IN CHINA

WASHER

**W10820039CM****BASKET DRIVE HUB**

Drive hub kit connects spin basket to the spin shaft. Fits Whirlpool top load washers.

MECHANICAL

MADE IN CHINA

**W10837741CM****LID STRIKE**

White lid lock strike. Fits Whirlpool top load washers.

TRIM

MADE IN CHINA

**W10876600CM****WATER PUMP**

120V, 60 Hz, 1.2A. Fits Whirlpool VM top load washers.

PUMP

MADE IN CHINA

WASHER

**W10919003CM****WATER PUMP**

120V, 60 Hz, 1.2A. Fits Whirlpool top load washers

PUMP

MADE IN CHINA

**W11165546CM****WATER VALVE**

120V, 60Hz, four coil valve. Fits Whirlpool top load washers.

WATER VALVE

MADE IN MEXICO

**W11168740CM****WATER VALVE**

120V, 60Hz, two coil cold water valve. Fits Whirlpool top load washers.

WATER VALVE

MADE IN CHINA

WASHER

**W11168743CM****WATER VALVE**

120V, 60Hz, single coil hot water valve. Fits Whirlpool top load washers.

WATER VALVE

MADE IN CHINA

**W11220205CM****WATER VALVE**

120V, 60Hz, two coil hot water valve. Fits Whirlpool top load washers.

WATER VALVE

MADE IN CHINA

**W11220230CM****WATER VALVE**

120V, 60Hz, three coil hot and cold water valve. Fits Whirlpool top load washers.

WATER VALVE

MADE IN MEXICO

WHIRLPOOL

WASHER



W11316255CM

WATER VALVE

120V, 60Hz, single coil hot water valve. Fits Whirlpool front load washer.

WATER VALVE

MADE IN CHINA



W11316256CM

WATER VALVE

120V, 60Hz, two coil cold water valve. Fits Whirlpool front load washer.

WATER VALVE

MADE IN CHINA



WP8299642CM

HEAVY DUTY CLUTCH KIT

Five pad heavy duty clutch for commercial machines. Fits Whirlpool direct drive washers.

MECHANICAL

MADE IN CHINA

WASHER



WPW10212596CM

WATER VALVE

120V, 60Hz, two coil cold water valve. Fits Whirlpool front load washer.

WATER VALVE

MADE IN CHINA



WPW10239942CM

WATER VALVE

120V, 60Hz, two coil diverter valve with barb connectors. Fits Whirlpool front load washer.

WATER VALVE

MADE IN CHINA



WPW10240513CM

STRIKE

White lid strike assembly. Fits Whirlpool VM Washing Machines.

TRIM

MADE IN CHINA

WASHER



WPW10271610CM

PRESSURE SWITCH

120V four spade connector pressure switch. Fits Whirlpool front load washer.

SWITCH

MADE IN CHINA



WPW10304342CM

PRESSURE SWITCH

120V four spade connector pressure switch. Fits Whirlpool front load washer.

SWITCH

MADE IN CHINA



MAT1

DP1 & DP2 COUNTER MAT
Ultra-heavy duty plastic top with premium extra thick 3/16" foam backing. Includes DP1 & DP2 Reference Guide graphic.

MARKETING

OTHER OEM

BROAN

MICROWAVE

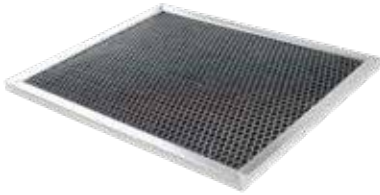

97007696CM

CHARCOAL FILTER

8 3/4" x 10 1/2" x 3/8" carbon fibre filter.
Fits Broan range hoods.

FILTER

MADE IN MEXICO

VENT HOOD



97012248CM

MOTOR

120V, 60Hz, 1.1A, CCW, 2 speed
motor with bracket and fan blade.

MOTOR

MADE IN CHINA

SUBZERO

REFRIGERATOR

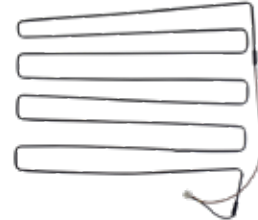

7014680CM

DEFROST HEATER

115V, 640W.
Fits Sub Zero 501F, 601F,
and 601F-2 models

HEATER

MADE IN CHINA

FISHER PAYKEL

DISHWASHER



529829CM

WATER VALVE

24V, 3/4 GHT inlet, 3/8" outlet.
Fits Fisher Paykel Dishwashers.

WATER VALVE

MADE IN CHINA

WASHER



420237PCM

WATER VALVE

24V, hot water valve.
Fits Fisher Paykel washing
machines.

WATER VALVE

MADE IN CHINA



420238PCM

WATER VALVE

24V, cold water valve.
Fits Fisher Paykel washing
machines.

WATER VALVE

MADE IN CHINA

BROAN

CHEMICAL



DWCLN

DISHWASHER CLEANER

Removes build-up, cleans, and
deodorizes. Environmentally
friendly, single use pouch.

CHEMICALS

MADE IN UNITED STATES

TOOL



CP-2

HOSE CLAMP PLIERS

Self locking grip plier with welded
tips to accept spring clamps.

TOOL

MADE IN CHINA

PANASONIC

MICROWAVE



F20555K00APCM

WAVE GUIDE COVER

4 3/8" x 4 3/8".
Fits Panasonic microwaves.

HEATER

MADE IN CHINA

UNIVERSAL

ACCESSORY



CIM15

ICE MAKER KIT (COPPER)

Includes 15' 1/4" copper tubing, self tapping saddle valve and compression fitting. Low lead valve and fittings.

INSTALL

MADE IN CHINA



CIM25

ICE MAKER KIT (COPPER)

Includes 25' 1/4" copper tubing, self tapping saddle valve and compression fitting. Low lead valve and fittings.

INSTALL

MADE IN CHINA



PIM25

ICE MAKER KIT (PVC)

Includes 25' plastic tubing, self tapping saddle valve, with male and female compression fitting. Low lead valve and fittings.

INSTALL

MADE IN CHINA



PIM25E

ICE MAKER KIT (ECONOMY)

Includes 25' plastic tubing, self tapping saddle valve, with male compression fitting. Low lead valve and fittings.

INSTALL

MADE IN CHINA

ACCESSORY



CSV2LL

TAP VALVE (LOW LEAD)

Self tapping saddle valve with 1/4" compression outlets. Fits 3/8" - 1 3/8" copper tubing.

INSTALL

MADE IN CHINA

BBQ



003230

BBQ IGNITER

3 pin rotary spark generator with knob. Fits Broil King, Broil Mate, Centro, Ducane, Dynasty, Jenn Air, Maytag, Turbos, and more.

IGNITER

MADE IN CHINA



003333

BBQ IGNITER

3 terminal, spark generator. Fits Backyard Grill, BBQ Grillware, Charbroil, Chargriller, Ducane, Kenmore, Master Chef, and more.

IGNITER

MADE IN CHINA

BBQ



003350

BBQ IGNITER

6 terminal, spark generator. Fits Altima, Amana Aussie, Backyard Classic, Brinkmann, Charboil, Charmglow, Duro, and more.

IGNITER

MADE IN CHINA



50000816

BBQ IGNITER

3 terminal, spark generator, required .75-.82" mounting hole. Fits Bakers & Chefs, BBQ Pro, Brinkmann, Charbroil, and more.

IGNITER

MADE IN CHINA



NEX200828

BBQ IGNITER

5 terminals spark generator with chrome knob. Fits Jen-Aire gas BBQ.

IGNITER

MADE IN CHINA

COOKING



MP15MA

SURFACE ELEMENT 4D6 1500W
208/240V, 1125/1500W, 6"
diameter, 4 turns, 'D' base.

ELEMENT

MADE IN CHINA



MP15YA

SURFACE ELEMENT 4D6 1500W
208/240V, 1125/1500W, 6"
diameter, 4 turns, 'Y' base.

ELEMENT

MADE IN CHINA



MP21MA

SURFACE ELEMENT 5D8 2100W
208/240V, 1575/2100W, 8"
diameter, 5 turns, 'D' base.

ELEMENT

MADE IN CHINA

COOKING



MP21YA

SURFACE ELEMENT
5T8 2100W
208/240V, 1575/2100W,
8" diameter, 5 turns, 'Y'
base.

ELEMENT

MADE IN CHINA



MP26MA

SURFACE ELEMEN
5D8 2600W
208/240V, 1950/2600W,
8" diameter, 5 turns, 'D'
base.

ELEMENT

MADE IN CHINA



MP26YA

SURFACE ELEMENT
5T8 2600W
208/240V, 1950/2600W,
8" diameter, 5 turns, 'Y'
base.

ELEMENT

MADE IN CHINA



SP12YA

SURFACE ELEMENT
3T6 1250W
208/240V, 938/1250W,
6" diameter, 3 turns, 'Y'
base.

ELEMENT

MADE IN CHINA

COOKING



SP21YA

SURFACE ELEMENT 4T8 2100W
208/240V, 1575/2100W, 8"
diameter, 4 turns, 'Y' base.

ELEMENT

MADE IN CHINA



Door Gaskets

OVEN DOOR GASKETS

OG1416	14" - 16"
OG1618	16" - 18"
OG1820	18" - 20"
OG2224	22" - 24"

GASKET

MADE IN CHINA



40A15CM

BULB 40W A15 APPLIANCE
40W 15 Amp appliance bulb. Fits
refrigerators and ranges.

LIGHT BULB

MADE IN CHINA

UNIVERSAL / MISC

COOKING - ELECTROLUX

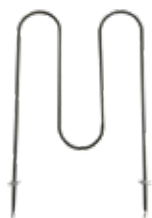

CM3200

BROIL ELEMENT
240V, 2400W.
12"W x 15"L, 3" Insert,
Spade terminal.
Replaces Electrolux
316203200.

ELEMENT MADE IN CHINA

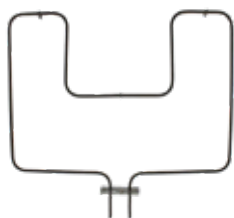

CM5002

BAKE ELEMENT
240V, 3000W.
19 3/4"W x 15 1/2"L, 3 1/4"
Insert, Spade terminal.
Replaces Electrolux
318255002.

ELEMENT MADE IN CHINA

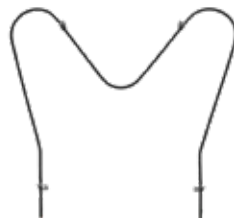

CM5104

BAKE ELEMENT
240V, 2600W.
19 1/4"W x 15 1/4"L, 3 3/8"
Insert, Spade terminal.
Replaces Electrolux
316075104.

ELEMENT MADE IN CHINA

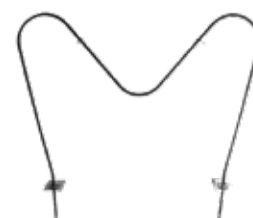

CM775

BAKE ELEMENT
208/240V, 1800/2400W.
19 3/8"W x 15"L, 3 1/4" Insert,
Spade terminal.
Replaces Electrolux
5303051519.

ELEMENT MADE IN CHINA

COOKING - GE

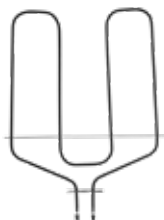

CM44K10002

BROIL ELEMENT
240V, 3410W.
16 1/2"W x 13 1/2"L, 2 3/4"
Insert, Spade terminal.
Replaces GE
WB44K10002.

ELEMENT MADE IN CHINA



CM44K10005

BAKE ELEMENT
240V, 2585W.
17 3/4"W x 15 1/2"L, 2 1/4"
Insert, Spade terminal.
Replaces GE
WB44K10005.

ELEMENT MADE IN CHINA

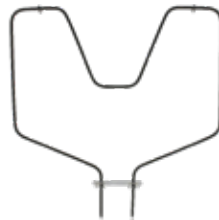

CM44K5012

BAKE ELEMENT
208/240V, 2138/2850W.
18"W x 15 3/8"L, 4" Insert,
Spade terminal.
Replaces GE
WB44K5012.

ELEMENT MADE IN CHINA

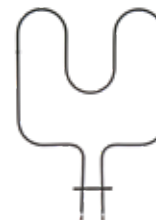

CM44K5013

BAKE ELEMENT
240V, 2000W.
13 3/4"W x 16"L, 2 7/8" Insert,
Spade terminal.
Replaces GE
WB44K5013.

ELEMENT MADE IN CHINA

COOKING - GE

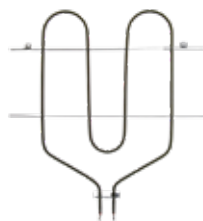

CM44T10009

BROIL ELEMENT
240V, 3410W.
10 1/4"W x 16 1/2"L, 2 1/2"
Insert, Spade terminal.
Replaces GE
WB44T10009.

ELEMENT MADE IN CHINA



CM44T10010

BAKE ELEMENT
240V, 2585W.
17 3/4"W x 17"L, 2 1/2" Insert,
Spade terminal.
Replaces GE
WB44T10010.

ELEMENT MADE IN CHINA

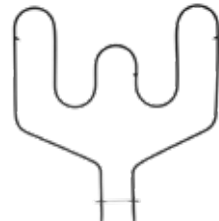

CM44T10011

BAKE ELEMENT
240V, 3410W.
16 1/2"W x 18"L, 2 1/8" Insert,
Spade terminal.
Replaces GE
WB44T10011.

ELEMENT MADE IN CHINA

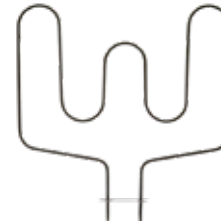

CM44T10014

BAKE ELEMENT
240V, 3800W.
16 7/8"W x 17 3/4"L, 2 1/2"
Insert, Spade terminal.
Replaces GE
WB44T10014.

ELEMENT MADE IN CHINA

COOKING - GE

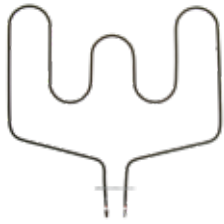

CM44T10018

BAKE ELEMENT
240V, 3400W.
17 3/4"W x 15 1/4"L, 2 1/2"
Insert, Spade terminal.
Replaces GE
WB44T10018.

MADE IN CHINA

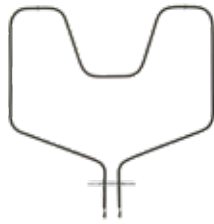

CM44X10009

BAKE ELEMENT
240V, 2585W.
17 3/4"W x 15 1/2"L, 2 7/8"
Insert, Spade terminal.
Replaces GE
WB44X10009.

MADE IN CHINA

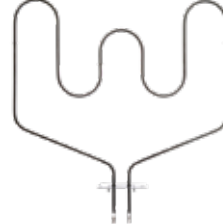

CM44X10016

BAKE ELEMENT
208/240V, 2650/3410W.
17 3/4"W x 15 1/2"L, 3 1/4"
Insert, Spade terminal.
Replaces GE
WB44X10016.

MADE IN CHINA

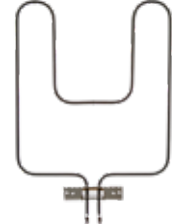

CM44X200

BAKE ELEMENT
208/240V, 2330/3100W.
13 1/4"W x 16 3/4"L, 2 1/2"
Insert, Screw terminal.
Replaces GE WB44X200.

MADE IN CHINA

COOKING - GE

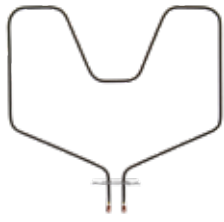

CM44X5082

BAKE ELEMENT
208/250V, 1869/2700W.
17 5/8"W x 14 3/4"L, 2.55"
Insert, Screw terminal.
Replaces GE
WB44X5082.

MADE IN CHINA

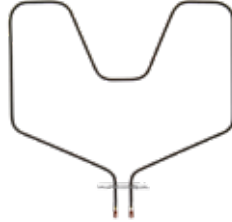

CM44X5099

BAKE ELEMENT
208/250V, 1869/2700W.
18"W x 16"L, 1.625" Insert,
Screw terminal.
Replaces GE
WB44X5099.

MADE IN CHINA

COOKING - WHIRLPOOL

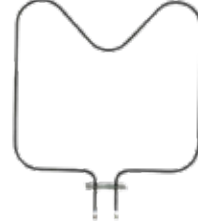

CM4000066

BAKE ELEMENT
208/240V, 2065/2750W,
16"W x 16"L, 2" Insert,
Spade terminal.
Replaces Whirlpool
Y04000066.

MADE IN CHINA



CM0750

BAKE ELEMENT
208/240V, 2100/2800W,
18 1/2"W x 16 3/8"L, 3 1/8"
Insert, Spade terminal.
Replaces Whirlpool
74010750.

MADE IN CHINA

COOKING - WHIRLPOOL



CM308180

BAKE ELEMENT
208/240V, 1950/2600W,
16 1/2"W x 15 7/8"L, 3"
Insert, Spade terminal.
Replaces Whirlpool
308180.

MADE IN CHINA

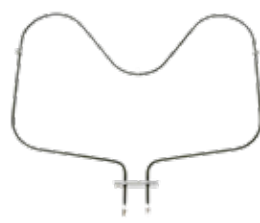

CM8477

BAKE ELEMENT
240V, 2400W.
20 3/8"W x 15 3/4"L, 2 5/8"
Insert, Spade terminal.
Replaces Whirlpool
W10308477.

MADE IN CHINA



CM866375

BAKE ELEMENT
208/240V, 1800/2400W.
19 1/2"W x 15 1/2"L, 3 1/2"
Insert, Spade terminal.
Replaces Whirlpool
866375.

MADE IN CHINA

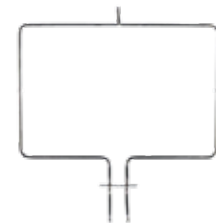

CM9716

BAKE ELEMENT
240V, 3600W.
20.56"W x 16.5"L, 3.11"
Insert, Spade terminal.
Replaces Whirlpool
W10779716.

MADE IN CHINA

DRYER



AT Series
UNIVERSAL THERMOSTAT
120/240V 14/10A 20°
Differential.

AT012	Adjustable range 135° to 175°	Open on rise
AT013	Adjustable range 175° to 215°	Open on rise
AT014	Adjustable range 210° to 250°	Open on rise
AT015	Adjustable range 250° to 290°	Open on rise
AT021	Adjustable range 90° to 130°	Close on rise
AT022	Adjustable range 140° to 180°	Close on rise

INSTALL

MADE IN CHINA



LD Series
UNIVERSAL THERMOSTAT
120/240V 10A/5A, SPDT
thermostat.

LD140CM	Open at 120°F	Close at 140°F
LD170CM	Open at 150°F	Close at 170°F
LD200CM	Open at 160°F	Close at 200°F
LD225CM	Open at 185°F	Close at 225°F
LD270CM	Open at 230°F	Close at 270°F

INSTALL

MADE IN CHINA

DRYER



Universal HVAC & Dryer Thermostat
120/240V 10A/5A, SPST
THERMOSTAT

L120CM	L160CM	L225CM	L340CM
L125CM	L165CM	L240CM	
L130CM	L170CM	L250CM	
L135CM	L175CM	L260CM	
L140CM	L180CM	L270CM	
L145CM	L190CM	L290CM	
L150CM	L200CM	L300CM	
L155CM	L205CM	L320CM	

INSTALL

MADE IN CHINA



DE382CM
COIL KIT

2 coil kit for standard "M" style gas valves. Fits most major brand dryers.

ELECTRICAL

MADE IN CHINA

DISHWASHER



514A
WATER VALVE

120V, 60Hz, 18NPTF adaptable inlet, 3/8" barb outlet. Base valve, use existing mounting and connectors.

WATER VALVE

MADE IN CHINA



DWUNICM
WATER VALVE

Kit includes flow washers and two solenoids. Recycle original mounting brackets.

WATER VALVE

MADE IN CHINA



SSDW7CM
DRAIN HOSE

Universal 7" kink resistant drain hose for dishwashers. 5/8", 3/4", 1-1/4" step down connectors.

DRAIN HOSE

MADE IN CHINA

MICROWAVE



10X12CM
WAVE GUIDE COVER
10" x 12" universal waveguide cover.

TRIM

MADE IN CHINA



16802CM
MICRO SWITCH
125/250V 15A, SPDT, 3/16" terminals. Fits ice makers, microwaves, and more.

SWITCH

MADE IN CHINA

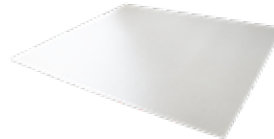

16X18CM
WAVE GUIDE COVER
16" x 18" universal waveguide cover.

TRIM

MADE IN CHINA



496CM
MICRO SWITCH
125/250V, 15A, SPDT, 1/4" terminals. Fits many microwave models.

SWITCH

MADE IN CHINA

REFRIGERATOR



ML Series
DEFROST THERMOSTAT
37TAM Style. Universal.

ML45CM	Open at 45°F	Close at 25°F
ML50CM	Open at 50°F	Close at 30°F
ML55CM	Open at 55°F	Close at 35°F
ML60CM	Open at 45°F	Close at 60°F
ML70CM	Open at 70°F	Close at 50°F

INSTALL

MADE IN CHINA



40A15CM
LIGHT BULB
40W A15 APPLIANCE
40W 15 Amp appliance bulb. Fits refrigerators and ranges.

TRIM

MADE IN CHINA



40A15LED
LED LIGHT BULB
A15 APPLIANCE
120V, 60Hz, 5W High efficiency LED. Replaces 40W refrigerators light bulb. Lower wattage and operating temperature.

SWITCH

MADE IN CHINA

REFRIGERATOR



Defrost Timers
UNIVERSAL TIMERS

120 - 240V, 8/15A, 50/60Hz, 1/2 Horsepower.
Timers from 6' 21" to 8' 30".

Part Number	Amps	Volts	Hertz	Horsepower	Timer
DT1	15	120	50/60	1/2	6hr, 21min
DT2	15	120	50/60	1/2	8hr, 21min
DT3	15	120	50/60	1/2	8hr, 25min
DT4	15	120	50/60	1/2	8hr, 30min
DT5	8	208/240	50/60	1/2	8hr, 21min

ELECTRICAL

MADE IN CHINA



The 40A15LED cannot be used in ovens!

The 40A15LED is intended for refrigerators only. Ovens operate at a higher temperature than the LED is rated to operate.

DO NOT ATTEMPT TO USE THE 40A15LED IN A COOKING APPLIANCE. USAGE IN THIS MANNER IS OUTSIDE OF THE PRODUCTS DESIGN AND MAY RESULT IN PRODUCT FAILURE OR PERSONAL INJURY.

REFRIGERATOR



16100CM

SWITCH

125/250V, 18/15A, SPST general purpose switch.

SWITCH

MADE IN CHINA



16300CM

SWITCH

125/250V, 18/15A, SPDT general purpose switch.

SWITCH

MADE IN CHINA



18806CM

LIGHT SWITCH

125V/5A, 250V/2.5A, 2 terminal with snap in mount. Universal light switch.

ELECTRICAL

MADE IN CHINA

REFRIGERATOR



18811CM

LIGHT SWITCH

125V/5A, 250V/2.5A, 3 terminal with snap in mount. Universal fan/light switch.

ELECTRICAL

MADE IN CHINA



18826CM

LIGHT SWITCH

125V/5A, 250V/2.5A, 2 terminal with snap in mount. Universal light switch.

ELECTRICAL

MADE IN CHINA



IM2000CM

ICE MAKER

Includes ice bin, water valve, and various harnesses. Used in all major brands.

ICE MAKERS

MADE IN CHINA

REFRIGERATOR



HS410

3-1 RELAY OVERLOAD
120V, 6.8LRA, 243 - 292MFD capacitor.

TRIM

MADE IN CHINA



HS810

3-1 RELAY OVERLOAD
120V, 4.05LRA, 145 - 175MFD capacitor.
Fits 1/2 - 1/5 HP compressors.

SWITCH

MADE IN CHINA



UHS410

3-1 RELAY OVERLOAD W/
RUN CAP
120V, 6.8LRA, 243 - 292MFD capacitor.
Fits 1/4 - 1/3 HP compressors.

TRIM

MADE IN CHINA



UHS810

3-1 RELAY OVERLOAD W/
RUN CAP
120V, 4.05LRA, 145 - 175MFD capacitor.
Fits 1/2 - 1/5 HP compressors.

SWITCH

MADE IN CHINA

WASHER



343

WATER VALVE
120V 60Hz, 2.0 - 10.8 GPM
1/2" I.D. hose barb.

WATER VALVE MADE IN CHINA



525

WATER VALVE
120V 60Hz, 2.0-10.8 GPM.
3/8" I.D. hose barb with
PVC adapter to 1/2".

WATER VALVE MADE IN CHINA



525-240V

WATER VALVE
220/240V 60Hz, 2.0-10.8
GPM. 3/8" I.D. hose barb
with PVC adapter to 1/2".

WATER VALVE MADE IN CHINA



526

WATER VALVE
120V 60Hz, 2.0-10.8 GPM.
3/8" I.D. hose barb with
PVC adapter to 1/2".

WATER VALVE MADE IN CHINA

WASHER



HM101CM

DRAIN HOSE COUPLING
1" straight hose mender. For
rubber drain hoses.

DRAIN HOSE MADE IN CHINA



SSD6CM

DRAIN HOSE
Universal 6' kink resistant drain
hose. 1", 1 1/8", 1 1/4" step down
connector to washer.

PVC DRAIN HOSE MADE IN CHINA



SSD6GECM

DRAIN HOSE
6' kink resistant drain hose.
Molded to accept WH16X513 clip.

PVC DRAIN HOSE MADE IN CHINA

WASHER



SSD8BCM

DRAIN HOSE - PCKG
Universal 8' kink resistant drain
hose w/clamp. 1", 1 1/8", 1 1/4" step
down connector to washer.

PVC DRAIN HOSE MADE IN CHINA



SSD8CM

DRAIN HOSE
Universal 8' kink resistant drain
hose. 1", 1 1/8", 1 1/4" step down
connector to washer.

PVC DRAIN HOSE MADE IN CHINA



SSD8GECM

DRAIN HOSE
8' kink resistant drain hose.
Molded to accept WH16X513 clip.

PVC DRAIN HOSE MADE IN CHINA

WASHER



DP1

UNIVERSAL PUMP
120V, 60 Hz, 1.25A, 85W.
Universal-fits multiple brands.

WATER VALVE

MADE IN CHINA



DP2

UNIVERSAL PUMP
Includes butt end connectors for
easy installation. "L" mounting
bracket.

WATER VALVE

MADE IN CHINA



MAT1

DP1 & DP2 COUNTER MAT
Ultra-heavy duty plastic top with
premium extra thick 3/16" foam
backing. Includes DP1 & DP2
Reference Guide graphic.

MARKETING

Current Replacement	OEM	DP1	DP2	DP1 Modification	DP2 Modification
436440	Bosch	✓	✗	No modification necessary	<i>Incorrect harness</i>
137108000	Electrolux	✓	✓	No modification necessary	Use reverse harness
137221600	Electrolux	✓	✗	No modification necessary	<i>Connector cannot clear pump housing</i>
137240800	Electrolux	✗	✓	<i>Incorrect mounting bracket</i>	Use reverse harness
137311900	Electrolux	✓	✓	No modification necessary	Use reverse harness
WH23x10016	GE	✓	✓	No modification necessary	Use reverse harness
WH23X10028	GE	✗	✓	<i>Missing foot mount slot</i>	Connect foot mount & plug to tab harness
WH23X10028	GE	✓	✗	Use spade harness	<i>Incorrect harness</i>
WH23x10030	GE	✓	✗	Use tab harness	<i>Connector interferes with outlet</i>
4681EA1007G	LG	✓	✓	Use tab harness	Use reverse harness
4681EA2001T	LG	✓	✓	Use tab harness	Use reverse harness
DC31-00054A	Samsung	✗	✓	<i>Missing reverse harness</i>	No modification necessary
DC96-00774A	Samsung	✗	✓	<i>Missing reverse harness</i>	No modification necessary
DC96-01328A	Samsung	✗	✓	<i>Missing reverse harness</i>	No modification necessary
DC96-01414A	Samsung	✗	✓	<i>Missing reverse harness</i>	No modification necessary
DC96-01585L	Samsung	✓	✗	Use spade harness	<i>Incorrect harness</i>
DC96-01700A	Samsung	✗	✓	<i>Missing reverse harness</i>	No modification necessary
280187	WP	✓	✗	Cut single tab on original harness	<i>Connector cannot clear pump housing</i>
22003059	WP	✗	✓	<i>Missing reverse harness</i>	No modification necessary
25001052	WP	✗	✓	<i>Missing reverse harness</i>	No modification necessary
34001098	WP	✗	✓	<i>Missing reverse harness</i>	No modification necessary
34001320	WP	✗	✓	<i>Missing reverse harness</i>	No modification necessary
34001340	WP	✗	✓	<i>Missing reverse harness</i>	No modification necessary
W10276397	WP	✓	✓	No modification necessary	Use reverse harness
W10391443	WP	✓	✗	Use spade harness	<i>Incorrect harness</i>
W10919003	WP	✓	✗	No modification necessary	<i>Incorrect harness</i>

WASHER

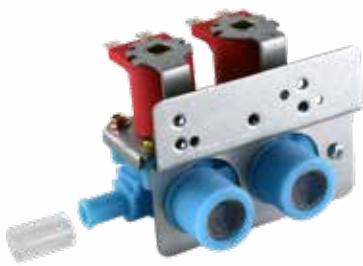

WV-1

WATER VALVE

Industry's most universal valve. Single valve replaces most 2 coil valves.

WATER VALVE

MADE IN CHINA



WV-2

WATER VALVE

Universal inlet valve with thermistor. Rotating solenoids and tabs allows for a variety of configurations.

WATER VALVE

MADE IN CHINA

ICE MACHINE



Screen Washers

SCREEN WASHER PACKS

SC300M25 30 Mesh 25 Pack

SC300MK 30 Mesh 100 Pack

SC600MK 60 Mesh 100 Pack

WATER VALVE

MADE IN UNITED STATES

ICE MACHINE



W7438K

VALVE REBUILD KIT - SINGLE

Repair kit for single coil laundry and dishwasher valves. Contains Armature, Diaphragm, guide and spring.

WATER VALVE

MADE IN UNITED STATES

ICE MACHINE



W7438K2

VALVE REBUILD KIT - DOUBLE

Repair kit for dual coil mixing valve. Contains 2 each of Armature, Diaphragm, guide and spring.

WATER VALVE

MADE IN UNITED STATES

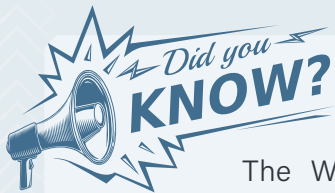

WV-1 UNIVERSAL

The WV-1 is the industry's most universal water valve. Aftermarket replacement part for most two-coil valves. Easily cover hundreds of SKU's with a single product.



Complete Kit

358276 Configuration

Replaces hundreds of valves, including;

- 205613
- 285805
- 358276
- 358277
- 21001932
- 22002360
- 134211400
- WH13X10024
- WH13X81

And many more!



WH13X10024 Configuration

Learn More at www.choicemfg.parts

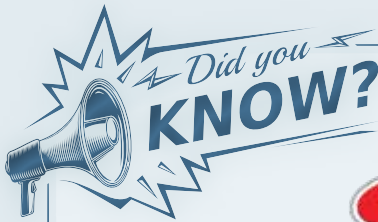

Proudly offering the Refrigeration Technologies Viper family of products.

Finally, a set of chemicals that are safe for the environment.

CHOICE MANUFACTURED PARTS IS THE EXCLUSIVE DISTRIBUTOR OF REFRIGERATION TECHNOLOGIES PRODUCT LINE TO THE AFTERMARKET APPLIANCE PARTS INDUSTRY. END USERS ARE ENCOURAGED TO READ INSTRUCTIONS CAREFULLY AND DISCONTINUE USE AND SEEK MEDICAL ADVICE IF ANY IRRITATION OCCURS. KEEP OUT OF REACH OF CHILDREN. SAFETY DATA SHEETS ARE AVAILABLE UPON REQUEST AT WWW.CHOICEMFG.PARTS. CHOICE MANUFACTURED PARTS DO NOT CONDUCT INDEPENDENT TESTING OR VERIFICATION OF ENVIRONMENTAL PRACTICES OR CLAIMS BY REFRIGERATION TECHNOLOGIES.



Non-toxic

Our chemicals use all-natural, non-toxic ingredients that are not only safe to handle, but won't kill your customers vegetation.



Biodegradable

Our chemicals flush away cleanly, without leaving any long-lasting environmental impact.



NSF Approved (For use around food)

Our chemicals are food-safe and can be used in any environment without concern for cross contamination.

REFRIGERATION TECHNOLOGIES

CHEMICAL



RT100S
BIG BLU LEAK
DETECTOR

CHEMICAL



RT150S
BIG BLU SUB
ZERO LEAK
DETECTOR

CHEMICAL



RT201BP
NYLOC BLUE
2-PACK

CHEMICAL



RT202W
NYLOC BLUE
2-PACK

CHEMICAL



RT300S
VIPER FOAM
SPRAYER

CHEMICAL



RT301S
VIPER PUMP
SPRAYER

CHEMICAL

CHEMICAL



RT310V
COIL
BRIGHTENER

CHEMICAL



RT320V
EVAPORATOR
CLEANER

CHEMICAL



RT330V
CONDENSER
CLEANER

CHEMICAL



RT340V
ALL-PURPOSE
CLEANER

CHEMICAL



RT350G
VIPER EVAP+
EVAPORATOR
COIL CLEANER

CHEMICAL



RT375A
COIL CLEANER
AEROSOL

CHEMICAL

CHEMICAL



RT400P
WETRAG HEAT
BLOCKING
PUTTY

CHEMICAL



RT410S
HEAT
BLOCKING GEL

CHEMICAL



RT500N
ICE MACHINE
CLEANER

CHEMICAL



RT600D
WATERLESS
HAND WIPES

CHEMICAL



RT640A
COIL
CLEANING
AEROSOL

CHEMICAL



RT910T
SILICONE
GREASE

CHEMICAL

REFERENCES TO ORIGINAL EQUIPMENT MANUFACTURERS' NAMES, MODELS, TRADEMARKS AND PART NUMBERS ARE USED FOR IDENTIFICATION PURPOSES ONLY. CHOICE MANUFACTURED PARTS IS NOT AFFILIATED, ENDORSED, OR SPONSORED BY ANY OEM

PAINT



1125

WHITE GLAZE TOUCH-UP PAINT

Lead-free, heatproof to 400F. Works on stoves, sinks, and other appliances.

PAINT MADE IN CHINA



1126

WHITE TOUCH-UP PAINT

Lead-free, heatproof to 400F. Works on stoves, sinks, and other appliances.

PAINT MADE IN CHINA



1438

ALMOND TOUCH-UP PAINT

Lead-free, heatproof to 400F. Works on stoves, sinks, and other appliances.

PAINT MADE IN CHINA



1440

BISQUE TOUCH-UP PAINT

Lead-free, heatproof to 400F. Works on stoves, sinks, and other appliances.

PAINT MADE IN CHINA

PAINT



1888

LT. BLUE TOUCH-UP PAINT

Lead-free, heatproof to 400F. Works on stoves, sinks, and other appliances.

PAINT MADE IN CHINA



1126

BLACK TOUCH-UP PAINT

Lead-free, heatproof to 400F. Works on stoves, sinks, and other appliances.

PAINT MADE IN CHINA



1454

PORCELAIN FILLER (CARDED, 10Z)

Works on ranges, sinks, showers, and other porcelain surfaces. Filler before touch-up.

PAINT MADE IN CHINA



1455

PORCELAIN FILLER, 10Z

Works on ranges, sinks, showers, and other porcelain surfaces. It can be sanded after dry.

PAINT MADE IN CHINA

PAINT



4233

GLOSSY BLACK SPRAY PAINT

Prevents rust, matches black appliances.

PAINT MADE IN CHINA



4250

APPLIANCE WHITE SPRAY PAINT

Prevents rust, matches white appliances.

PAINT MADE IN CHINA



4264

BBQ BLACK SPRAY PAINT

Prevents rust. Black BBQ paint is heatproof.

PAINT MADE IN CHINA

HVAC/COMMERCIAL ICE

ICE MACHINE



HV074

DUMP/PURGE VALVE

120V, 50/60Hz, Universal Dump Valve kit.

WATER VALVE

MADE IN CHINA



HV074A

DUMP/PURGE VALVE

240V, 50/60Hz, Universal Dump Valve kit.

WATER VALVE

MADE IN CHINA

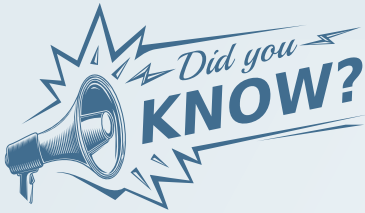

- ☞ Includes two brackets that rotate 360° for multiple mounting configurations.
- ☞ Includes locking pin, allowing the coil to rotate 360° for multiple mounting configurations.
- ✓ Coil available in 120V or 240V, intermittent duty (4 min. on / 5 min. off).
- ✓ Terminals are 6.3*0.8 Tin plated brass per UL310 specifications.
- ☞ Valve will produce less than 70dB, one second after applying power.
- ☞ Operates between 25" and 72" water column.
- ☞ Can be easily disassembled for cleaning.

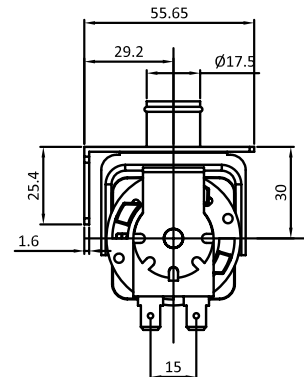
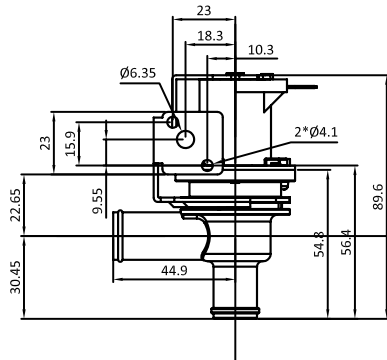
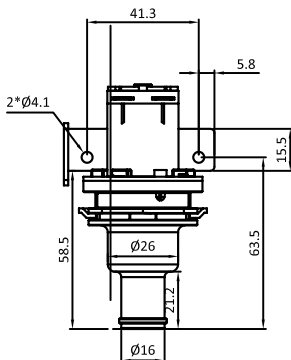

HOSHIZAKI

ICE MACHINE



IH4A7077G01
FLOAT SWITCH
 120V float switch. Fits Hoshisaki stackable Crescent Cuber.

SWITCH

MADE IN CHINA



IH4A7077G02
FLOAT SWITCH
 240V float switch. Fits Hoshisaki stackable Crescent Cuber.

SWITCH

MADE IN CHINA



IH3U0111-01
WATER VALVE
 120V, 60Hz, 3.96 GPM. Fits Hoshisaki Crescent Cuber ice makers.

WATER VALVE

MADE IN CHINA

HOSHIZAKI

ICE MACHINE



IH3U0111-02
WATER VALVE
 120V, 60Hz, 2.11 GPM. Fits Hoshisaki Crescent Cuber ice makers.

WATER VALVE

MADE IN CHINA



IH3U0111-03
WATER VALVE
 120V, 60Hz, 1.58 GPM. Fits Hoshisaki Crescent Cuber ice makers.

WATER VALVE

MADE IN CHINA



IH3U0111-04
WATER VALVE
 120V, 60Hz, .79 GPM. Fits Hoshisaki Crescent Cuber ice makers.

WATER VALVE

MADE IN CHINA



IH3U0150-01
SOLENOID VALVE
 120V, 60Hz, 0.52 GPM single coil. Fits Hoshisaki KM-201/280/301 and KML200/351/451 machines.

WATER VALVE

MADE IN CHINA

MANITOWOC

ICE MACHINE



56675
WATER VALVE
 120V, 0.75 GPM. Fits Manitowoc 2405283 and 7601123.

WATER VALVE

MADE IN CHINA



56675A
WATER VALVE
 240V, 0.75 GPM. Fits "Q" series Manitowoc 2405293 and 7601133 from 1995-2005.

WATER VALVE

MADE IN CHINA



IH40003579
WATER VALVE
 120V, 60Hz, 5W
 Replaces 040003579

WATER VALVE

MADE IN ITALY



IH6063
WATER VALVE
 120V, 60Hz
 Replaces 000006063

WATER VALVE

MADE IN ITALY

MANITOWOC

ICE MACHINE

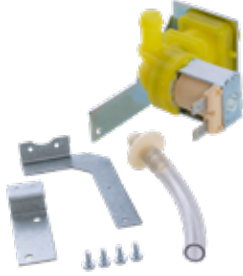

IH9120

WATER VALVE

120V, 60Hz, 5W, .53 GPM. Includes brackets and tube. Replaces Manitowoc 000009120.

WATER VALVE



MADE IN CHINA

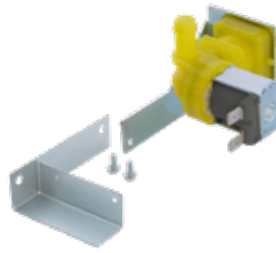

IH9121

WATER VALVE

220/240V, 50/60Hz, 6W, 1.8 GPM. Includes brackets. Replaces Manitowoc 000009121.

WATER VALVE



MADE IN CHINA

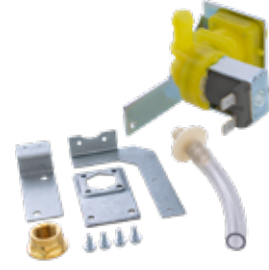

IH9122

WATER VALVE

220/240V, 50/60Hz, 6W, .78 GPM. Includes brackets, tube and fitting. Replaces Manitowoc 000009122.

WATER VALVE



MADE IN CHINA



MANITOWOC

ICE MACHINE

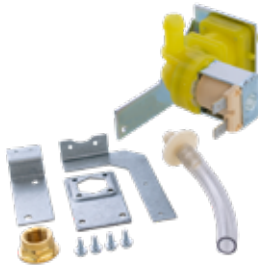

IH9123

WATER VALVE

120V, 60Hz, 5W, flow .78 GPM. Includes brackets, tube and fitting. Replaces Manitowoc 000009123.

WATER VALVE



MADE IN CHINA

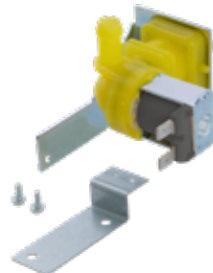

IH9124

WATER VALVE

220/240V, 50/60Hz, 6W, 2.64 GPM. Includes brackets. Replaces Manitowoc 000009124.

WATER VALVE



MADE IN CHINA



IH6058

WATER VALVE

220V, 60Hz, single coil valve with mounting bracket. Fits Manitowoc ice machines.

WATER VALVE



MADE IN CHINA



ICE-O-MATIC

ICE MACHINE



IH1011337-28

INLET VALVE

120V Replaces Ice-O-Matic 1011337-28.

WATER VALVE



MADE IN CHINA



IH9041105-01

INLET VALVE

120V 60Hz. Replaces Ice-O-Matic IH9041105-01.

WATER VALVE



MADE IN CHINA



IH9041105-02

INLET VALVE

240V 60Hz. Replaces Ice-O-Matic IH9041105-02.

WATER VALVE



MADE IN CHINA



ICE-O-MATIC

ICE MACHINE



IH9041105-03
PURGE VALVE
240V 60Hz. Replaces Ice-O-Matic IH9041105-03.

WATER VALVE

MADE IN CHINA



IH9041105-04
PURGE VALVE
240V 60Hz Replaces Ice-O-Matic IH9041105-04.

WATER VALVE

MADE IN CHINA



IH9041105-05
PURGE VALVE
120V 60Hz Replaces Ice-O-Matic IH9041105-05

WATER VALVE

MADE IN CHINA

SCOTSMAN

ICE MACHINE



IH2004 (110V)
WATER VALVE
60Hz rotatable coil.

- 12-1434-01 IH2004
- 12-1434-02 IH2004
- 12-1434-04 IH2004
- 12-1434-08 IH2004
- 12-1434-09 IH2004

Includes .25 and .50 GPM flow washer kit with instructions.

MADE IN UNITED STATES



IH2005 (110V)
IH2005A (240V)
WATER VALVE
60Hz rotatable coil.

- 12-1646-01 IH2005
- 12-1646-02 IH2005
- 12-1646-03 IH2005A
- 12-1646-04 IH2005A
- 12-1646-05 IH2005
- 12-1646-06 IH2005A
- 12-1646-07 IH2005
- 12-1646-08 IH2005A
- 12-1646-10 IH2005A
- 12-1646-11 IH2005A

Includes .15, .50, .75 and 1.0 GPM flow washer kit with instructions.

MADE IN UNITED STATES



IH2006 (110V)
IH2006A (240V)
WATER VALVE
60Hz rotatable coil.

- 12-1900-01 IH2006
- 12-1900-02 IH2006A
- 12-1900-03 IH2006
- 12-1900-04 IH2006A
- 12-1900-05 IH2006
- 12-1900-06 IH2006A
- 12-1900-07 IH2006
- 12-1900-09 IH2006A
- 12-1900-10 IH2006

Includes .25, .33, .50 and .75 GPM flow washer kit with instructions.

MADE IN UNITED STATES



IH2007 (110V)
IH2007A (240V)
WATER VALVE
60Hz rotatable coil.

- 12-2261-01 IH2007
- 12-2261-02 IH2007A
- 12-2261-03 IH2007A
- 12-2261-04 IH2007
- 12-2313-01 IH2007
- 12-2313-02 IH2007A
- 12-2313-03 IH2007A
- 12-2313-04 IH2007

Includes .33 and .75 GPM flow washer kit with instructions.

MADE IN UNITED STATES



IH2010 (110V)
IH2010A (240V)
WATER VALVE
60Hz rotatable coil.

- 12-2446-01 IH2010
- 12-2446-02 IH2010A
- 12-2446-03 IH2010
- 12-2446-04 IH2010A
- 12-2446-05 IH2010
- 12-2446-06 IH2010A
- 12-2446-21 IH2010
- 12-2446-22 IH2010A
- 12-2446-23 IH2010
- 12-2446-24 IH2010A
- 12-2446-25 IH2010

Includes .50, .75 and 1.0 GPM flow washer kit with instructions.

MADE IN UNITED STATES



11051401CM
PURGE VALVE - 240V
240V, 60Hz coil, 0.715 outlet, 0.625 inlet body. Fits Scotsman Ice Machines. Replaces Horton 560/240CDC.

WATER VALVE

MADE IN UNITED STATES



11051402CM
PURGE VALVE - 120V
120V, 60Hz coil, 0.715 outlet, 0.625 inlet body. Fits Scotsman Ice Machines. Replaces Horton 560CDC.

WATER VALVE

MADE IN UNITED STATES

SCOTSMAN

ICE MACHINE



IH2410-21
WATER VALVE
 120V 0.22 GPM.
 Fits Scotsman 12-2410-02.

WATER VALVE MADE IN UNITED STATES



IH2447-01
WATER VALVE
 120V, 0.33 GPM.
 Fits Scotsman 12-2447-01

WATER VALVE MADE IN UNITED STATES



IH2548-01
WATER VALVE
 24VAC, 1.0 GPM.
 Fits Scotsman 1996-2005.

WATER VALVE MADE IN UNITED STATES

SCOTSMAN

ICE MACHINE



IH2666-01
WATER VALVE
 24VAC, 2.6 GPM.
 Fits Scotsman 1996-2005.

WATER VALVE MADE IN UNITED STATES



IH2922-01
WATER VALVE
 115V, 1.32 GPM.
 Fits Scotsman 2006-current.

WATER VALVE MADE IN UNITED STATES



IH2922-02
WATER VALVE
 240V, 1.32 GPM.
 Fits Scotsman 2006-current.

WATER VALVE MADE IN UNITED STATES

SCOTSMAN

ICE MACHINE



IH2990-01
WATER VALVE
 120 V
 Fits Scotsman 12-2990-01

WATER VALVE MADE IN MEXICO



IH4014
WATER VALVE
 240V, 0.110 GPM
 Fits Crystal Tips 80406305

WATER VALVE MADE IN UNITED STATES

GE

PTAK



WP12X10002CM
KNOB
 1 1/2" diameter, white.
 Fits GE Ptak units.

KNOB MADE IN CHINA

UNIVERSAL

ICE MACHINE

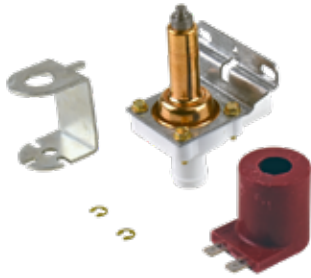

45912CD

DUMP VALVE - 120V

120V, 60Hz coil, packaged to allow 3 coil positions. Fits Manitowoc, SerVend, Scotsman, Ice-O-Matic and Marvel ice machines.

WATER VALVE

MADE IN UNITED STATES



45912CDA

DUMP VALVE - 240V

240V, 60Hz coil, packaged to allow 3 coil positions. Fits Manitowoc, SerVend, Scotsman, Ice-O-Matic and Marvel ice machines.

WATER VALVE

MADE IN UNITED STATES

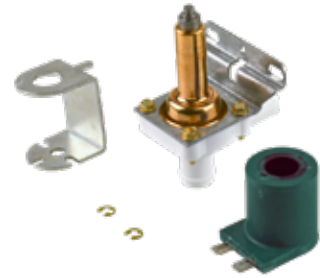

45912CDV

DUMP VALVE - 24V

24V, 60Hz coil, packaged to allow 3 coil positions. Fits Manitowoc, SerVend, Scotsman, Ice-O-Matic and Marvel ice machines.

WATER VALVE

MADE IN UNITED STATES



UNIVERSAL

DRYER



AT Series

UNIVERSAL THERMOSTAT

120/240V 14/10A 40°

Differential.

AT012	Adjustable range 135° to 175°	Open on rise
AT013	Adjustable range 175° to 215°	Open on rise
AT014	Adjustable range 210° to 250°	Open on rise
AT015	Adjustable range 250° to 290°	Open on rise
AT021	Adjustable range 90° to 130°	Close on rise
AT022	Adjustable range 140° to 180°	Close on rise



LD Series

UNIVERSAL THERMOSTAT

120/240V 10A/5A, SPDT

thermostat.

LD140CM	Open at 120°F	Close at 140°F
LD170CM	Open at 150°F	Close at 170°F
LD200CM	Open at 160°F	Close at 200°F
LD225CM	Open at 185°F	Close at 225°F
LD270CM	Open at 230°F	Close at 270°F

UNIVERSAL

DRYER



Universal HVAC & Dryer Thermostat

120/240V 10A/5A, SPST THERMOSTAT

L120CM	L160CM	L225CM	L340CM
L125CM	L165CM	L240CM	
L130CM	L170CM	L250CM	
L135CM	L175CM	L260CM	
L140CM	L180CM	L270CM	
L145CM	L190CM	L290CM	
L150CM	L200CM	L300CM	
L155CM	L205CM	L320CM	

REFRIGERATOR



ML Series
DEFROST THERMOSTAT
37T Style. Universal.

ML45CM	Open at 45°F	Close at 25°F
ML50CM	Open at 50°F	Close at 30°F
ML55CM	Open at 55°F	Close at 35°F
ML60CM	Open at 45°F	Close at 60°F
ML70CM	Open at 70°F	Close at 50°F

UNIVERSAL

ICE MACHINE



Screen Washers
SCREEN WASHER PACKS

SC300M25	30 Mesh	25 Pack
SC300MK	30 Mesh	100 Pack
SC600MK	60 Mesh	100 Pack

WATER VALVE MADE IN UNITED STATES



W7438K

VALVE REBUILD KIT - SINGLE
Repair kit for single coil laundry and dishwasher valves. Contains Armature, Diaphragm, guide and spring.

WATER VALVE MADE IN UNITED STATES



W7438K2

VALVE REBUILD KIT - DOUBLE
Repair kit for dual coil mixing valve. Contains 2 each of Armature, Diaphragm, guide and spring.

WATER VALVE MADE IN UNITED STATES

UNIVERSAL

ICE MACHINE



Copper Ice Maker Kit
Includes 1/4" copper tubing, self tapping saddle valve and compression fitting. Low lead valve and fittings.

CIM15	15 ft	Copper
CIM25	25 ft	Copper

WATER VALVE MADE IN CHINA



PVC Ice Maker Kit
Includes plastic tubing, self tapping saddle valve, with male and female compression fitting. Low lead valve and fittings.

PIM25	25 ft	PVC
PIM25E	25 ft	Economy

WATER VALVE MADE IN CHINA



CSV2LL
TAP VALVE

Self tapping saddle valve with 1/4" compression outlets. Fits 3/8" - 1 3/8" copper tubing. Low lead.

WATER VALVE MADE IN CHINA

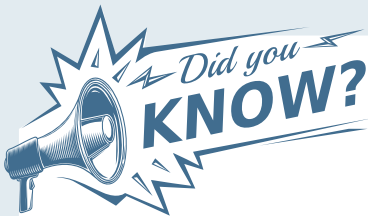

In house assembly for low-volume, low production run water valves

Work with our team to build your niche market/low volume water valves here in the United States.



HVAC



03336A-000CM

SAIL SWITCH W/METAL PLUNGER
125V, 5Amp/250V, 3Amp. Includes switch, metal sail, and 24" leads.

MOTOR

MADE IN CHINA



LH680005CM

PILOT BURNER ASSEMBLY
Pilot expansion with 3 lead SPDT switch. Fits Carrier, Bryant, Day & Night and Payne furnaces.

BURNER

MADE IN CHINA



LH680512CM

ELECTRODE
Electrode for LH68005 pilot burner. Fits Carrier, Bryant, Day & Night and Payne furnaces.

SENSOR

MADE IN CHINA

HONEYWELL

LENNOX

HVAC

HVAC



S8610U3009CM

IGNITION MODULE
24VAC, 50/60Hz, 0.2A current draw. Replaces Honeywell, Johnson, and Robert Shaw versions.

ELECTRICAL

MADE IN UNITED STATES



S8910U3000CM

HSI IGNITION MODULE
Universal hot surface ignition module for 120VAC igniter. Replaces multiple Honeywell, White-Rodgers, Robertshaw and Johnson ignition modules.

ELECTRICAL

MADE IN UNITED STATES



60J00CM

IGNITION MODULE
24VAC, 50/60Hz, MV4A, Blower 6FLA @ 120VAC, 0.2A. Fits Lennox gas furnaces.

ELECTRICAL

MADE IN UNITED STATES

CARRIER

UNIVERSAL

HVAC



318984-753CM

DRAFT INDUCE MOTOR
115V, 60 Hz, 1.8A, 1/2 HP, 3300 RPM, CW. Includes fan blade and harness adapters.

MOTOR

MADE IN CHINA



K5895CM

BLOWER FAN ASSEMBLY
Single speed motor with mounting bracket, 6" wire leads with 110V plug. Includes 3.75" x 2.0" blower wheel. Fits Nutone bath fans.

MOTOR

MADE IN CHINA



M6700BCM

UTILITY MOTOR
120V, .55 Amp, 3000 RPM, CW/CCW. Reversible direction. Fits Bohn, Heatcraft and more.

MOTOR

MADE IN CHINA

HVAC

MOTORS

PART NUMBER	AMPS	VOLTS	RPM	SHAFT	ROTATION	DETAILS
 EM550CM	0.40120V	3000	n/a	CCW		4 1/2" blower wheel, 9" lead w/120V plug
 EM551CM	0.40/0.75	120V	1550/3000	n/a	CW	Two speed motor, 9" lead w/ 120V plug
 EM552CM	0.65120V	3000	n/a	CCW		9" lead w/ 120V plug
 EM553CM	0.50120V	3000	n/a	CCW		9" lead w/ eyelet
 EM554CM	0.50/0.70	120V	1550/3000	n/a	CCW	9" lead w/ 3 pin
 EM555CM	0.65120V	3000	n/a	CCW		9" lead w/ 120V plug
 EM670CM	0.32120V	3000	3/16 x 1 1/4	CW/CCW		4 1/2" & 5 1/2" Fan Blades
 EM672CM	0.32240V	3000	3/16 x 1 1/4	CW/CCW		4 1/2" & 5 1/2" Fan Blades
 EM673CM	0.34/0.55	120V	3000/1550	3/16 x 1 1/4	CW/CCW	4 1/2" & 5 1/2" Fan Blades
 EM675CM	0.5/1.0	120/240V	3000	3/16 x 2 3/8	CW/CCW	5 1/2" Fan Blades
 EM690CCM	0.32120V	3000	3/16 x 1 1/4	CW/CCW		4 1/2" & 5 1/2" Fan Blades
 EM6700BCM	0.55120V	3000	n/a	CW/CCW		Reversible direction. Fits Bohn, Heatcraft and more.
 EM9998CM	0.12240V	3000	n/a	CW/CCW		Universal evaporator fan motor.
 EM9999CM	0.26120V	3000	n/a	CW/CCW		Universal evaporator fan motor.

INDEX

3-60336-001CM	92	6602-001655CM	4	482731CM	93	8181846CM	106
6-3700340CM	87	6931EL3002MCM	52	491133CM	11	8182119CM	106
10X12CM	119	6931EL3003CM	52	511629PCM	86	8182703CM	106
16X18CM	119	6931EL3003DCM	53	529829CM	113	8182862CM	107
34FHTCM	78	6931EL3004BCM	53	607335CM	10	8183202CM	95
35-6465CM	105	7432P136-60CM	75	611475CM	11	8183954CM	90
35-6780CM	105	7733P410-60CM	75	611666CM	11	8190232CM	90
40A15CM	115, 119	16100CM	120	612102CM	11	8193762CM	78
40A15LED	119	16300CM	120	622058CM	11	8194001CM	78
53-0918CM	86	16802CM	119	628334CM	11	8201515CM	95
60J00CM	133	18806CM	120	628366CM	94	8201756CM	95
197CM	82	18811CM	120	633970CM	11	8201786CM	95
343	121	18826CM	120	637572CM	11	8203536CM	76
496CM	119	28808CM	5	642239CM	11	8206232ACM	90
514A	118	38034CM	105	661570CM	4	8269145CM	78
525	121	38174CM	5	661658CM	78	8270020CM	78
525-240V	121	45912CD	131	675813CM	78	8270182CM	79
526	121	45912CDA	131	691366CM	87	8273103CM	76
1125	125	45912CDV	131	694089CM	87	8318084CM	107
1126	125	49621CM	86	755058CM	10	8531669CM	79
1438	125	56461PCM	86	759296CM	94	8531964CM	87
1440	125	56675	127	819470CM	95	8540101CM	4
1454	125	56675A	127	902894CM	79	8540221CM	107
1455	125	80040CM	106	913108CM	79	8540751CM	107
1888	125	91938CM	107	1110702ACM	91	8547157CM	4
003230	114	91939CM	107	1129316CM	91	8547160CM	87
003333	114	165314CM	10	2155469ACM	91	8547168CM	4
03336A-000CM	133	201566PCM	104	2180353CM	92	8547174CM	87
003350	114	211124CM	5	2187172CM	92	8557403CM	87
4027EL1001ACM	51	211125CM	5	2188874CM	92	8557882CM	87
4036ER2004ACM	54	279311CM	82	2198597CM	92	8557884CM	87
4036ER4001BCM	54	279347CM	82	2315549CM	92	8566493CM	88
4233	125	279393CM	82	2315576CM	92	8572270CM	88
4250	125	279640CM	83	3148952CM	74	8577274CM	88
4264	125	279769CM	83	3148953CM	74	9704230CM	103
4280EN4001CCM	55	279787CM	83	3149400CM	74	9743986CM	79
4280FR4048ECM	55	279816CM	83	3149404CM	74	9755542CM	76
4400EL2001ACM	4	279827CM	83	3203459CM	15	9758060CM	76
4560EL3001ACM	51	279973CM	83	3355806CM	105	10004364CM	10
4561EL3002ACM	51	280148CM	83	3363394CM	105	11051401CM	129
4581DD3002ACM	51	280187CM	104	3363892CM	105	11051402CM	129
4581DD3003BCM	51	285671CM	104	3387223CM	84	12001541CM	82
4581EL2002CCM	52	285744CM	104	3390719CM	84	12001656CM	74
4581EL2002HCM	52	285753ACM	104	3392519CM	84	12001676CM	74
4681EA1007GCM	55	285753CM	104	3394652CM	4	12002121CM	74
4681EA2001TCM	55	285785CM	104	3400918CM	78	12002351CM	107
4681EA2002HCM	55	285790CM	104	3405281CM	85	12002355CM	91
4681EL1008ACM	52	285811CM	105	3406105CM	85	12002744CM	91
4681JB1029BCM	53	285852ACM	105	3406107CM	85	12004119CM	10
4738ER1002ACM	55	303373KCM	83	3406108CM	85	12112425CM	5
4902FA1665WCM	55	306508CM	83	3949238CM	106	12544002CM	91
4933DD3001BCM	51	312959CM	4	3949247CM	106	21002026CM	82
5220FR2006HCM	55	318984-753CM	133	3977456CM	86	21352320CM	5
5220FR2008CCM	55	330031CM	74	3977767CM	86	22003483CM	5
5220FR2008ECM	56	330190CM	74	4151750CM	103	25001052CM	104
5220FR2008FCM	56	339392CM	84	4317933CM	78	27001007CM	5
5220FR2075CCM	56	339956CM	84	4317943CM	92	33001003CM	84
5220FR2075LCM	56	341241CM	4	4318046CM	92	33001755CM	20
5221EA1009BCM	56	349241CM	85	4318047CM	93	33001808CM	84
5221EA2001CCM	56	349241TCM	85	4387489CM	93	33002032CM	20
5221JA2006DCM	53	349639CM	85	4387490CM	93	33002795CM	84
5230W1A012ECM	53	358684CM	105	4387503CM	93	33002970CM	84
5231EL1001CCM	52	389140CM	106	4388931CM	93	37001042CM	85
5231EL1002ECM	52	389248CM	106	4388932CM	93	37001142CM	85
5301EL1001JCM	56	395048CM	4	4389102CM	93	40111201CM	4
5835EL1002ACM	52	420237PCM	113	4389147CM	93	50000816	114
6322FR2046CCM	56	420238PCM	113	4391996CM	86	61004888CM	94
6323EL2001BCM	52	422133CM	10	4392065CM	86	61005273CM	94
6500EL3001ACM	56	422244CM	12	4392067CM	86	61005789CM	94
6500JB2002XCM	53	422245CM	12	4393799CM	74	61005988CM	94
6501KW2002ACM	56	422748CM	10	4456027CM	75	67003753CM	94
6600JB1010ACM	54	422749CM	10	7014680CM	113	67005154CM	94
6601EL3001ACM	52	425458CM	10	8053334CM	75	67006322CM	94
6601ER1006ECM	57	436440CM	12	8181694CM	106	67006531CM	94

74003122CM	75	242252702CM	24	ACQ73244001CM	54	DA62-00914ACM	66
74007498CM	75	242253002CM	24	ADG56656401CM	53	DA62-00914BCM	66
74008248CM	75	242303001CM	24	AEQ72909603CM	54	DA62-00930ACM	66
74010824CM	75	243297609CM	24	AGM73269501CM	57	DA62-01477ACM	67
74011243CM	75	297250000CM	24	AJU33450701CM	51	DA62-01477CCM	67
74011489CM	75	297250000CM	26	AJU72992601CM	54	DA62-02360ACM	67
97007696CM	113	316220722CM	13	AJU73213301CM	57	DA62-02360BCM	67
97012248CM	113	316220725CM	13	AT012	118, 131	DA63-02284BCM	67
131476300CM	18	316220728CM	13	AT013	118, 131	DA66-00649BCM	67
131763202CM	26	316220729CM	13	AT014	118, 131	DA81-01345BCM	67
131763310CM	26	316220804CM	13	AT015	118, 131	DA81-06013ACM	67
131775600CM	18	316220805CM	13	AT021	118, 131	DA82-01396ACM	67
131825900CM	18	316238201CM	13	AT022	118, 131	DA82-01397ACM	68
131863007CM	19	316354400CM	13	CIM15	114, 132	DA82-01415ACM	68
131873500CM	19	316354402CM	13	CIM25	114, 132	DA82-02367ACM	68
134120900CM	19	316419137CM	14	CM44K5012	7, 116	DA97-00258CCM	68
134144700CM	26	316419140CM	14	CM44K5013	7, 116	DA97-02203GCM	68
134161100CM	5	316419141CM	14	CM44K10002	7, 116	DA97-04049DCM	68
134371220CM	26	316419145CM	14	CM44K10005	7, 116	DA97-05368ACM	68
134440200CM	19	316419353CM	14	CM44T10009	7, 116	DA97-05422ACM	68
134503600CM	4	316419380CM	14	CM44T10010	8, 116	DA97-07365GCM	68
134515300CM	27	316419821CM	14	CM44T10011	8, 116	DA97-07549BCM	69
134550800CM	27	316419828CM	14	CM44T10014	8, 116	DA97-07592ACM	69
134637810CM	27	316436000CM	14	CM44T10018	8, 117	DA97-07603BCM	69
134762000CM	27	316436001CM	15	CM44X200	8, 117	DA97-08059ACM	69
134762010CM	27	316455400CM	15	CM44X5082	8, 117	DA97-08680GCM	69
134792700CM	19	316455410CM	15	CM44X5099	8, 117	DA97-12540GCM	69
134793500CM	19	316455420CM	15	CM44X10009	8, 117	DA97-12540KCM	69
134793511CM	19	316489400CM	15	CM44X10016	8, 117	DA97-12608ACM	69
134813600CM	19	316489403CM	15	CM0750	9, 117	DA97-12609CCM	69
134844410CM	19	316655001CM	15	CM775	7, 116	DA97-12815BCM	70
134936800CM	27	318191023CM	15	CM3200	7, 116	DA97-13070ACM	70
134959340CM	27	807047901CM	18	CM5002	7, 116	DA97-13718CCM	70
137108000CM	27	807048001CM	18	CM5104	7, 116	DA97-13829CCM	70
137114000CM	20	809006501CM	18	CM8477	9, 117	DA97-14471ACM	70
137221600CM	27	5300809640CM	17	CM9716	9, 117	DA97-15217DCM	70
137240800CM	28	5303161174CM	28	CM308180	9, 117	DA97-19898ACM	70
137292700CM	4	5303280326CM	5	CM866375	9, 117	DC31-00054ACM	70
137311900CM	28	5303281153CM	20	CM4000066	9, 117	DC31-00054DCM	70
137315300CM	4	5303283286CM	20	CP-2	113	DC31-00055DCM	59
137353300CM	28	5303917625CM	25	CSV2LL	114, 132	DC31-00055HCM	60
137353302CM	28	5303917625CM	26	D7712603CM	95	DC31-00098ACM	70
137353303CM	28	5303918202CM	25	D7824706QCM	95	DC31-00187ACM	59
137513300CM	20	5303918214CM	25	DA31-00020ECM	63	DC32-00007ACM	60
137539200CM	20	5303918277CM	25	DA31-00070ECM	63	DC47-00016ACM	60
154430501CM	16	5303918344CM	25	DA31-00146BCM	63	DC47-00018ACM	60
154459903CM	16	5303918493CM	25	DA31-00146ECM	63	DC47-00019ACM	60
154513601CM	16	5303918549CM	25	DA31-00146JCM	63	DC47-00022ACM	60
154578801CM	16	5303935058CM	16	DA31-00334CCM	63	DC47-00032ACM	60
154579101CM	17	5303935066CM	16	DA32-00006RCM	63	DC61-01215BCM	60
154580301CM	17	5303935067CM	16	DA32-00006SCM	64	DC61-01257MCM	71
154622001CM	17	5303937182CM	20	DA32-00011CCM	64	DC61-02595ACM	60
154637401CM	17	5303937183CM	20	DA32-00024WCM	64	DC61-02610ACM	61
154701001CM	17	5304404821CM	25	DA32-00029QCM	64	DC61-02613ACM	61
154827601CM	17	5304457724CM	21	DA32-10104NCM	64	DC61-03128ACM	61
218470300CM	22	5304458371CM	25	DA32-10105RCM	64	DC62-00142GCM	71
218698900CM	22	5304477389CM	21	DA32-10105VCM	64	DC62-00214LCM	71
218969902CM	22	5304477398CM	21	DA32-10105XCM	64	DC62-00214MCM	71
240338101CM	22	5304485917CM	28	DA32-10109WCM	64	DC62-30312JCM	71
240356402CM	22	5304500204CM	17	DA47-00243KCM	65	DC62-30314KCM	71
240570206CM	22	5304505231CM	28	DA47-00244DCM	65	DC62-30314LCM	59
240597203CM	22	5304506545CM	16	DA47-00244QCM	65	DC64-00802ACM	71
241509402CM	22	5304509444CM	21	DA47-00244UCM	65	DC64-00828ACM	61
241537103CM	22	5304509457CM	21	DA47-00244WCM	65	DC64-01570ACM	71
241542001CM	23	5304509706CM	16	DA47-00247HCM	65	DC66-00470ACM	72
241675704CM	23	5304513033CM	26	DA47-00301DCM	65	DC66-00470BCM	72
241696606CM	23	5304516818CM	17	DA47-00311ACM	65	DC66-00470CCM	72
241798231CM	23	5304517871CM	21	DA47-00322HCM	65	DC66-00531BCM	72
241920106CM	23	5304518968CM	18	DA47-00322JCM	66	DC66-00805ACM	4
241993001CM	23	5304521062CM	26	DA47-00424LCM	66	DC90-10128NCM	72
241993101CM	23	5304523152CM	21	DA47-00424MCM	66	DC93-00154ACM	61
242018304CM	23	5304523155CM	21	DA47-00434ACM	66	DC93-00634ACM	61
242044020CM	23	5304529782CM	21	DA59-00294BCM	65	DC96-00077ACM	72
242046001CM	24	5305877995CM	26	DA61-04702ACM	66	DC96-00882CCM	61
242077705CM	24	5308002385CM	28	DA61-04703ACM	66	DC96-00887ACM	61
242196204CM	24	A00126401CM	18	DA61-05435ACM	65	DC96-01414ACM	72
242252603CM	24	A00126501CM	18	DA61-14306ACM	66	DC96-01585LCM	72

DC96-01700ACM	72	IH3U0111-02	127	MJX41869202CM	54	W10181323CM	96
DC96-01703BCM	72	IH3U0111-03	127	ML45CM	119, 131	W10181986CM	76
DC97-05280WCM	73	IH3U0111-04	127	ML50CM	119, 131	W10188389CM	96
DC97-12150ACM	61	IH3U0150-01	127	ML55CM	119, 131	W10189077CM	108
DC97-14486ACM	62	IH4A7077G01	127	ML60CM	119, 131	W10189703CM	96
DC97-15459DCM	73	IH4A7077G02	127	ML70CM	119, 131	W10190961CM	96
DC97-15459GCM	73	IH2004	129	MP15MA	6, 115	W10190965CM	96
DC97-15459HCM	73	IH2005	129	MP15YA	6, 115	W10190981CM	96
DC97-16013ACM	62	IH2005A	129	MPX21MA	6	W10195416CM	79
DC97-16350CCM	73	IH2006	129	MP21MA	115	W10195622CM	80
DC97-16350DCM	73	IH2006A	129	MP21YA	6, 115	W10195839CM	80
DC97-16350ECM	73	IH2007	129	MP26MA	6, 115	W10195840CM	80
DC97-16742ACM	62	IH2007A	129	MP26YA	6, 115	W10196393CM	97
DC97-16782ACM	62	IH2010	129	NEX200828	114	W10198086CM	5
DC97-16782ECM	62	IH2010A	129	OG1416	6, 115	W10205415CM	5
DD33-01002ACM	59	IH2410-21	130	OG1618	6, 115	W10207752CM	91
DD62-00084ACM	59	IH2447-01	130	OG1820	6, 115	W10207928CM	76
DD66-00023ACM	59	IH2548-01	130	OG2224	6, 115	W10207930CM	76
DD81-02132ACM	59	IH2666-01	130	PIM25	114, 132	W10208415CM	108
DD82-01118ACM	59	IH2922-01	130	PIM25E	114, 132	W10208631ACM	91
DD94-01006ACM	59	IH2922-02	130	RT100S	124	W10238100CM	97
DE47-20034ACM	62	IH2990-01	130	RT150S	124	W10247306CM	108
DE63-00196ACM	62	IH4014	130	RT201BP	124	W10248595CM	97
DE63-00666ACM	62	IH6058	128	RT202W	124	W10250667CM	108
DE63-30016GCM	63	IH6063	127	RT300S	124	W10257451CM	97
DE63-30016HCM	63	IH9120	128	RT301S	124	W10258275CM	80
DE91-70063DCM	63	IH9121	128	RT310V	124	W10258562CM	97
DE382CM	118	IH9122	128	RT320V	124	W10271506CM	97
Defrost Timers	119	IH9123	128	RT330V	124	W10276397CM	108
DG31-00005ACM	58	IH9124	128	RT340V	124	W10279866CM	97
DG34-00017ACM	58	IH1011337-28	128	RT350G	124	W10289387CM	108
DG34-00020ACM	58	IH9041105-01	128	RT375A	124	W10295405CM	88
DG34-00025ACM	58	IH9041105-02	128	RT400P	124	W10300022CM	97
DG34-00027BCM	58	IH9041105-03	129	RT410S	124	W10300024CM	97
DG34-00030ACM	58	IH9041105-04	129	RT500N	124	W10312696CM	97
DG44-01002ACM	58	IH9041105-05	129	RT600D	124	W10314173CM	89
DG44-01008ACM	58	IH40003579	127	RT640A	124	W10327249CM	80
DG44-01009ACM	58	IM3CM	40	RT910T	124	W10327250CM	80
DG94-00520ACM	58	IM2000CM	120	S8610U3009CM	133	W10328463CM	89
DG96-00110ECM	58	K5895CM	133	S8910U3000CM	133	W10331686CM	76
DP1	122	L120CM	118, 131	SAMKIT	62	W10341320CM	98
DP2	122	L125CM	118, 131	SAMKITHD	62	W10341329CM	98
DT1	119	L130CM	118, 131	SC300M25	123, 132	W10348269CM	80
DT2	119	L135CM	118, 131	SC300MK	123, 132	W10359269CM	89
DT3	119	L140CM	118, 131	SC600MK	123, 132	W10359270CM	89
DT4	119	L145CM	118, 131	SP12YA	6, 115	W10366605CM	98
DT5	119	L150CM	118, 131	SP21YA	6, 115	W10383615CM	98
DWCLN	113	L155CM	118, 131	SSD6CM	121	W10384183CM	98
DWUNICM	118	L160CM	118, 131	SSD6GECM	121	W10388414CM	5
EAU61383503CM	57	L165CM	118, 131	SSD8BCM	121	W10391443CM	109
EAU61524007CM	54	L170CM	118, 131	SSD8CM	121	W10404050CM	109
EAU61644105CM	54	L175CM	118, 131	SSD8GECM	121	W10408179CM	98
EAU61865301CM	51	L180CM	118, 131	SSDW7CM	118	W10409079CM	109
EAU61865302CM	51	L190CM	118, 131	UHS410	120	W10420083CM	98
EBF49827801CM	57	L200CM	118, 131	UHS810	120	W10420741CM	89
EBF61315802CM	57	L205CM	118, 131	W7438K	123, 132	W10440729CM	109
EM550CM	134	L225CM	118, 131	W7438K2	123, 132	W10440786CM	109
EM551CM	134	L240CM	118, 131	W10001130CM	107	W10441696CM	76
EM552CM	134	L250CM	118, 131	W10006384CM	5	W10462778CM	77
EM553CM	134	L260CM	118, 131	W10082861CM	79	W10465252CM	109
EM554CM	134	L270CM	118, 131	W10111905CM	88	W10479155CM	98
EM555CM	134	L290CM	118, 131	W10117655CM	88	W10490648CM	103
EM670CM	134	L300CM	118, 131	W10118756CM	88	W10498976CM	98
EM672CM	134	L320CM	118, 131	W10120998CM	88	W10510667CM	80
EM673CM	134	L340CM	118, 131	W10122496CM	95	W10514214CM	109
EM675CM	134	LA1053CM	88	W10122559CM	95	W10515057CM	99
EM690CCM	134	LD140CM	118, 131	W10124096CM	96	W10515058CM	99
EM6700BCM	134	LD170CM	118, 131	W10128551CM	96	W10528947CM	89
EM9998CM	134	LD200CM	118, 131	W10130913CM	107	W10536347CM	109
EM9999CM	134	LD225CM	118, 131	W10136934CM	4	W10563095CM	89
F20555K00APCM	113	LD270CM	118, 131	W10140917CM	108	W10581874CM	109
HM101CM	121	LGKIT	53	W10144820CM	108	W10594329CM	99
HS410	120	LGKITHD	53	W10149355CM	76	W10594330CM	99
HS810	120	LH680005CM	133	W10158291CM	79	W10599356CM	110
HV074	126	LH680512CM	133	W10158389CM	79	W10605427CM	110
HV074A	126	M6700BCM	133	W10178988CM	108	W10648041CM	80
IH3U0111-01	127	MAT1	122	W10179146CM	96	W10661045CM	110

W10667607CM	99	WB2X7909CM	32	WD21X25468CM	34	WP3186491CM	77
W10672617CM	103	WB2X8228CM	32	WD26X10013CM	34	WP3355458CM	90
W10674618CM	103	WB2X8391CM	39	WD26X10051CM	35	WP8268743CM	82
W10674621CM	103	WB2X9998CM	32	WD26X10053CM	35	WP8299642CM	112
W10683603CM	110	WB02X10700CM	38	WD35X21038CM	35	WP12729128CM	102
W10695459CM	99	WB02X11096CM	38	WE1M333CM	36	WP31001556CM	90
W10705575CM	81	WB02X11124CM	38	WE1M504CM	36	WP37001298CM	90
W10712394CM	81	WB02X11550CM	38	WE1M654CM	37	WPW10082853CM	82
W10712395CM	81	WB02X24790CM	29	WE1M964CM	37	WPW10212596CM	112
W10715708CM	99	WB02X32793CM	38	WE1M1067CM	36	WPW10212598CM	82
W10715709CM	99	WB02X35607CM	38	WE01X20374CM	35	WPW10239942CM	112
W10721967CM	110	WB03T10284CM	29	WE01X20378CM	35	WPW10240513CM	112
W10730972CM	110	WB03X27704CM	38	WE01X20378CM	46	WPW10251076CM	102
W10731415CM	103	WB06X10596CM	38	WE3M51CM	37	WPW10271610CM	112
W10754448CM	110	WB06X10608CM	38	WE3M52CM	37	WPW10304342CM	112
W10780045CM	110	WB06X10625CM	39	WE3X75CM	37	WPW10511278CM	77
W10780048CM	110	WB06X10638CM	39	WE03X10016CM	35	WR2X9144CM	41
W10807813CM	103	WB07K10043CM	29	WE03X23881CM	36	WR2X9393CM	41
W10807828CM	77	WB7X7183CM	32	WE4M416CM	37	WR02X10585CM	40
W10814173CM	99	WB7X7189CM	32	WE4M519CM	37	WR02X12650CM	40
W10820039CM	111	WB07X10034CM	29	WE04X28977CM	36	WR9X480CM	46
W10822278CM	99	WB10X10021CM	39	WE09X20441CM	36	WR9X483CM	46
W10822580CM	100	WB10X32782CM	39	WE12M51CM	5	WR9X502CM	46
W10823377CM	100	WB13K21CM	29	WE12X82CM	5	WR9X10041CM	46
W10837240CM	89	WB13T10045CM	29	WE12X20395CM	36	WR09X20002CM	40
W10837741CM	111	WB13X25262CM	29	WE13X68KCM	36	WR17X11653CM	40
W10838965CM	100	WB13X25500CM	29	WE18X25100CM	36	WR17X11705CM	40
W10846093CM	81	WB15X10022CM	39	WH1X2026CM	5	WR30X10093CM	41
W10846539CM	100	WB15X10023CM	39	WH01X10061CM	46	WR30XUNI	41
W10854032CM	100	WB16X28654CM	30	WH01X10310CM	46	WR50X10025CM	41
W10857622CM	77	WB17T10006CM	30	WH01X10462CM	46	WR50X10065CM	41
W10860916CM	77	WB17X5113CM	30	WH01X24180CM	5	WR50X10068CM	41
W10861225CM	89	WB23M24CM	30	WH01X24434CM	47	WR50X10069CM	41
W10873791CM	100	WB23M91CM	30	WH01X24697CM	5	WR50X10070CM	41
W10876537CM	81	WB23T10015CM	31	WH01X27538CM	5	WR50X10071CM	42
W10876600CM	111	WB24T10022CM	30	WH2X10032CM	50	WR50X10073CM	42
W10882923CM	100	WB24T10025CM	30	WH03X30517CM	47	WR51X442CM	42
W10884390CM	100	WB24T10027CM	30	WH05X24185CM	47	WR51X443CM	42
W10892387CM	91	WB24T10029CM	30	WH08X24594CM	47	WR51X10031CM	42
W10898291CM	77	WB24T10058CM	30	WH08X32657CM	47	WR51X10038CM	42
W10898951CM	100	WB24T10063CM	30	WH08X32697CM	47	WR51X10053CM	42
W10916040CM	101	WB24T10119CM	31	WH12X1075CM	48	WR51X10055CM	42
W10918546CM	77	WB24T10145CM	31	WH12X10068CM	47	WR51X10101CM	42
W10919003CM	111	WB24T10146CM	31	WH12X10069CM	47	WR55X10025CM	43
W11025920CM	90	WB24T10153CM	31	WH12X10076CM	47	WR55X10899CM	43
W11043013CM	101	WB26X10038CM	39	WH12X10108CM	47	WR55X11132CM	43
W11050447CM	103	WB27T11005CM	31	WH12X10173CM	48	WR55X26671CM	43
W11082871CM	81	WB27T11006CM	31	WH12X10311CM	48	WR55X32696CM	43
W11084656CM	81	WB27T11229CM	31	WH12X10321CM	48	WR57X77CM	35
W11087463CM	101	WB27X11094CM	39	WH12X10412CM	48	WR57X10023CM	43
W11104452CM	101	WB27X11213CM	31	WH12X10413CM	48	WR57X10024CM	43
W11117909CM	101	WB28K10222CM	31	WH12X10476CM	48	WR57X10026CM	43
W11127829CM	101	WB29K10023CM	32	WH12X10479CM	48	WR57X10032CM	43
W11130208CM	101	WB29K10024CM	32	WH12X10530CM	48	WR57X10033CM	43
W11162730CM	77	WB34X21271CM	40	WH13X10024CM	48	WR57X10051CM	44
W11164593CM	101	WB34X21610CM	40	WH13X10025CM	49	WR60X162CM	45
W11165546CM	111	WB39X10034CM	40	WH13X10026CM	49	WR60X10074CM	44
W11168740CM	111	WD01X21740CM	32	WH13X10027CM	49	WR60X10141CM	44
W11168743CM	111	WD8X227CM	35	WH13X10029CM	49	WR60X10168CM	44
W11174006CM	101	WD8X228CM	35	WH13X10033CM	49	WR60X10172CM	44
W11197783CM	91	WD08X23476CM	32	WH13X10037CM	49	WR60X10185CM	44
W11205082CM	102	WD12X271CM	33	WH13X10053CM	49	WR60X10204CM	44
W11220205CM	111	WD12X10074CM	33	WH13X10059CM	49	WR60X10220CM	44
W11220230CM	111	WD12X10267CM	33	WH13X10066CM	49	WR60X10257CM	44
W11226500CM	102	WD12X10304CM	33	WH13X23974CM	49	WR60X10258CM	45
W11239857CM	5	WD12X10426CM	33	WH13X26534CM	50	WR60X10307CM	45
W11239944CM	102	WD12X24058CM	33	WH13X26535CM	50	WR60X10348CM	45
W11316255CM	112	WD12X24060CM	33	WH23X10028CM	49	WR60X21886CM	45
W11316256CM	112	WD15X10003CM	33	WH23X10030CM	50	WR60X21887CM	45
W11353079CM	90	WD15X10014CM	33	WH23X24178CM	50	WR60X23584CM	45
W11364931CM	90	WD15X10015CM	34	WH23X27419CM	50	WR60X25858CM	45
W11412300CM	81	WD15X22948CM	34	WH44X10288CM	50	WR60X30922CM	45
W11462342CM	102	WD15X24213CM	34	WH49X10042CM	50	WR60X31522CM	46
W11545764CM	81	WD19X10032CM	34	WP12X10002CM	37	WR62X10055CM	46
W11577195CM	102	WD21X10060CM	34	WP12X10002CM	130	WV-1	123
W11579560CM	102	WD21X10268CM	34	WP2217220CM	102	WV-2	123
WB02K10254CM	29	WD21X10490CM	34	WP2315539CM	102	Y54414CM	90

Some tools were made to do it all.

The universal DP1 & DP2 Washer Pumps.

Universal parts mean having the right part when you need it.

Having the right part when you need it means profit.

Current Replacement	OEM	DP1	DP2	DP1 Modification	DP2 Modification
436440	Bosch	✓	✗	No modification necessary	<i>Incorrect harness</i>
137108000	Electrolux	✓	✓	No modification necessary	Use reverse harness
137221600	Electrolux	✓	✗	No modification necessary	<i>Connector cannot clear pump housing</i>
137240800	Electrolux	✗	✓	<i>Incorrect mounting bracket</i>	Use reverse harness
137311900	Electrolux	✓	✓	No modification necessary	Use reverse harness
WH23x10016	GE	✓	✓	No modification necessary	Use reverse harness
WH23X10028	GE	✗	✓	<i>Missing foot mount slot</i>	Connect foot mount & plug to tab harness
WH23X10028	GE	✓	✗	Use spade harness	<i>Incorrect harness</i>
WH23x10030	GE	✓	✗	Use tab harness	<i>Connector interferes with outlet</i>
4681EA1007G	LG	✓	✓	Use tab harness	Use reverse harness
4681EA2001T	LG	✓	✓	Use tab harness	Use reverse harness
DC31-00054A	Samsung	✗	✓	<i>Missing reverse harness</i>	No modification necessary
DC96-00774A	Samsung	✗	✓	<i>Missing reverse harness</i>	No modification necessary
DC96-01328A	Samsung	✗	✓	<i>Missing reverse harness</i>	No modification necessary
DC96-01414A	Samsung	✗	✓	<i>Missing reverse harness</i>	No modification necessary
DC96-01585L	Samsung	✓	✗	Use spade harness	<i>Incorrect harness</i>
DC96-01700A	Samsung	✗	✓	<i>Missing reverse harness</i>	No modification necessary
280187	WP	✓	✗	Cut single tab on original harness	<i>Connector cannot clear pump housing</i>
22003059	WP	✗	✓	<i>Missing reverse harness</i>	No modification necessary
25001052	WP	✗	✓	<i>Missing reverse harness</i>	No modification necessary
34001098	WP	✗	✓	<i>Missing reverse harness</i>	No modification necessary
34001320	WP	✗	✓	<i>Missing reverse harness</i>	No modification necessary
34001340	WP	✗	✓	<i>Missing reverse harness</i>	No modification necessary
W10276397	WP	✓	✓	No modification necessary	Use reverse harness
W10391443	WP	✓	✗	Use spade harness	<i>Incorrect harness</i>
W10919003	WP	✓	✗	No modification necessary	<i>Incorrect harness</i>



DP1 UNIVERSAL KIT



DP2 UNIVERSAL KIT

CROSS-REFERENCE

Pumps normally cross-referenced to those listed above are also replaceable by the DP1 & DP2, including the following;

DP1 replaces 285998, 8181684, 131802000, 131889800, 134051100, 134051200, 134740500, 134740800, 137108000, 137108100, 137151800, 137151900, 137151800KITK, Askol M75, WH23X10013

DP2 replaces 6271680, 22001982, 22002550, 22002794, 22002939, 22003244, 131802000, 131889800, 134051100, 134740800, 137108000, 137151900, DC31-00054A, and DC96-00774A

CHOICE

MANUFACTURED PARTS

 Email

info@choicemfg.parts
www.choicemfg.parts

 Phone

P : (331) 702-2051
F : (630) 857-9260

 Address

2012 Corporate Lane
Suite 124
Naperville, IL 60563

2023 Collection

All content contained in this document is the property of Choice Manufactured Parts. No part of this document may be duplicated or reproduced without written permission from Choice Manufactured Parts.
Part numbers and illustrations are for identification purposes only. Items offered for sale are not represented to be manufactured by the company that built the original equipment.